



**INTRODUCTION**

Just like all of our other categories of products, Leapers UTG® continuously strives to provide a comprehensive selection of firearm specific mounting systems and modular system accessories. Trust in us to continue to listen to our customer's suggestions and feedback and devote our full energy, attention, and effort to developing what is asked of us from you, our loyal customers. We do not just offer parts and tools; every item incorporates the UTG® touch. Designed, developed, prototyped, and executed entirely in-house. If you find yourself here looking to modularly update and kit out your MSR from the ground up, you need not look any further. Our full lineup of products are always ready out of the box and come complete with everything you need to get up and gunning. New for 2019, Leapers UTG® and UTG PRO® is excited to debut and introduce our Made in USA Micro Gas Block, MR556, G3, RPR, and Ultra Slim handguards, and a whole new series of optic dedicated mounts.

**LEAPERS, INC.**  
**THE BEST NEVER REST**  
**LIFETIME WARRANTY**

**ABSOLUTE COMMITMENT TO QUALITY**

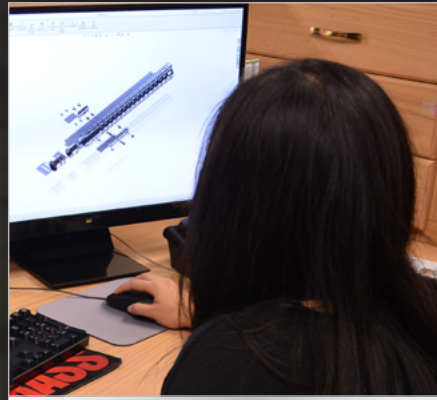

Intensive Engineering and Programming



State of the Art Manufacturing

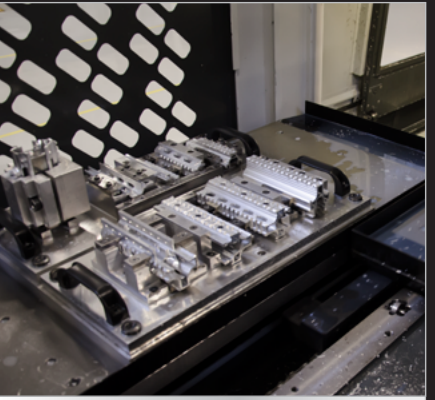

Optimized Fixture Design and Layout

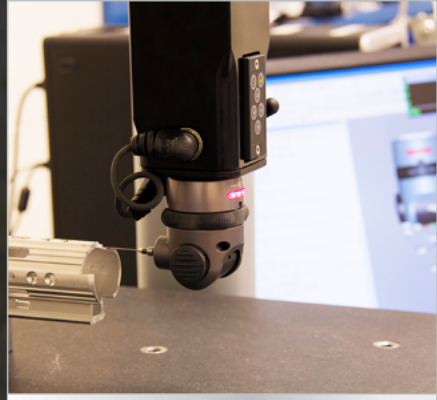

Total Commitment to Precision



Relentless Search for Excellence



Best Valued Products on the Market

**UTG PRO MOUNTING SYSTEMS**  
**COMPLETE SOLUTIONS - HANDGUARDS, MOUNTS, & ACCESSORIES**

**NEW AND MUST HAVE PRODUCTS FOR 2019**







	MR556   G3   RPR® HANDGUARDS	AR15 HANDGUARDS	AR308 HANDGUARDS	RDM20   RMR®   MRO®   T1   UNIVERSAL RISERS	MICRO GAS BLOCKS	CARRY HANDLE   BARREL   HANDGUARD RAIL MOUNTS	AK HANDGUARDS & MOUNTS	SKS   MOSIN MOUNTS	SHOTGUN MOUNTS	M14   M1   10/22   BOLT ACTION MOUNTS	MP5   G3   G36 MOUNTS	ANGLE & BARREL MOUNTS	AIR RIFLE MOUNTS
<b>PAGE RANGE</b>	<b>P.064 - P.065</b> MR556 Super Slim Free Float M-LOK® Rail .....064 MR556 Super Slim Free Float Keymod Rail .....064 G3 Super Slim M-LOK® Rail .....064 Ruger RPR® Super Slim Free Float M-LOK® Rail .....065 Ruger RPR® Super Slim Free Float Keymod Rails .....065	<b>P.066 - P.077</b> Ultra Slim Free Float M-LOK® Rails .....066-067 Super Slim Free Float M-LOK® Rails .....068-069 Super Slim Free Float Keymod Rails .....070-071 Super Slim Free Float 2-Tone Rails .....072 Super Slim Free Float Rails .....073 Super Slim Drop-in M-LOK® Rails .....074-075 Super Slim Drop-in Keymod Rails .....074-075 Super Slim Drop-in Rails .....074-075 Drop-in Quad Rails .....076-077	<b>P.078 - P.083</b> Super Slim Free Float M-LOK® Rails .....078-079 Super Slim Free Float Keymod Rails .....080-081 Super Slim Free Float Rails .....082 Drop-in Quad Rail .....083	<b>P.084 - P.087</b> RDM20 Super Slim Risers .....084 RMR® Super Slim Risers .....085 MRO Super Slim Risers .....085 T1 Super Slim Risers .....085 Universal Super Slim Risers .....086 20MOA Compensator Riser .....086 Classic Universal Risers .....087	<b>P.088</b> Adjustable Gas Block .....088 Micro Gas Block .....088	<b>P.089</b> Carry Handle Rail Mount .....089 Tri-rail Barrel Mount .....089 Picatinny Rails .....089	<b>P.090 - P.093</b> Super Slim Keymod Rails .....090-091 Quad Rails .....092 Quick Detach Side Mount .....093 Steel Side Plate .....093 QD Low Profile Top Rail .....093	<b>P.094</b> SKS Receiver Cover with Integrated Picatinny Rail and Shell Deflector .....094 SKS Shell Deflector .....094 Mosin Nagant Tri-rail Mount .....094	<b>P.095</b> Mossberg 500 Receiver Top Rail .....095 Remington 870 Receiver Top Rail .....095 Remington 870 Saddle Mount Receiver Top Rail .....095 Saiga 12 Quad Rail .....095	<b>P.096</b> M14 M1 Scope Mount .....096 M1 Carbine Scope Mount .....096 10/22 Scout Rail .....096 10/22 Low Profile Scope Mount .....096 Remington 700 Long Action Scope Mounts .....096 Remington 700 Short Action Scope Mounts .....096	<b>P.097</b> MP5 G3 Low Profile Claw Mount .....097 MP5 G3 Steel Clow Mount with Stanag Dimension .....097 G36 Carry Handle Scope .....097 G36 Handguard Picatinny Rails .....097	<b>P.098</b> Rifle Barrel Mounts .....098 Shotgun Barrel Mounts .....098	<b>P.099</b> Low Profile Dovetail to Picatinny Rail Adaptor .....099 Compensation Mount for RWS Diana Airgun with T06 Trigger .....099 Dovetail to Picatinny/Weaver Adaptor Mount .....099
<b>HIGHLIGHTS</b>	New products include the Super Slim Free Float Handguard available in both M-LOK® and Keymod modular systems for the HK MR556 and Ruger RPR® Bolt Action rifle featuring the same lightweight characteristics and feature set made known by the UTG PRO® USA Made Super Slim lineup of AR15 handguards. Making its return and new for 2019, is our revamped HK91/G3 handguard, an M-LOK® Super Slim handguard that uses a simple drop-in installation	Take a look at our extensive lineup of Super Slim handguards for the AR15 MSR. With multiple lengths, finishes, drop-in and free float system options, and models available in both M-LOK® and Keymod, we have a solution to tailor to any shooter's particular requirements. Check out our UTG PRO® USA Made Ultra Slim handguard featuring the most in weight reduction features to include a Titanium precision barrel nut and weight reducing lightening cuts made throughout the handguard	Super Slim Handguards available in both M-LOK® and Keymod featuring the same design implementations and feature sets as their AR15 MSR counterparts. New to 2019 are models available for the DPMS Gen. 2	A plethora of both dedicated and universal mounts and risers for installation on MIL-STD-1913 Picatinny equipped rifles or rear sight dovetails of pistols. Multiple heights available to include heights for absolute co-witness, lower 1/3 co-witness, low profile, and more	.750" Fixed and adjustable micro gas blocks to go with all of our UTG PRO® USA Made Super Slim and Ultra Slim Free Float handguard systems	Keeping the classics in mind, some times less is more. For those who appreciate the minimalist approach in regards to AR15 builds, our selection of standard handguard mounts and carry handle rear sights and accessories will make you feel right at home all from a one stop shopping experience	Continuing our lineage of AK handguards, mounts, and accessories, make sure you stop and see our series of Super Slim Keymod Drop-in handguards. Available in three different lengths for a variety of different AK platform variants, the lightweight, sleek, and modular Super Slim puts personalization in mind without the added bulk and weight	In order to satisfy our need to be your one stop shopping solution. We make it a very important note to keep stock of classic mounts not easily found in today's markets. Customers will continue to enjoy from us mounts and accessories made for the venerable SKS and Mosin Nagant	Still very much prevalent in the shooting community, Saiga 12s and more traditional shotguns are still considered a staple with us. Continue to enjoy a variety of different optic mounts and handguards for these staples.	Here you will find a garden variety of different mounts and accessories for the aforementioned platforms. Several different solutions are available to quickly and easily mount optics and accessories without the need for permanent modification or a gunsmith.	Enjoy various scope and accessory mounting options for these classics here. Simple, affordable, and quality solutions for these fan favorites.	Universal MIL-STD-1913 Picatinny mounts ideally used for adding accessories onto firearms that lack mountable handguards, flat tops, etc. Universal Barrel mounts offer quick solutions for adding a bipod or flashlight to traditional firearms not equipped with MIL-STD-1913 Picatinny rails.	We enjoy plinking just as much as the rest of you and value the importance of getting an optic set up just right on an airgun. Look out for our barrel droop compensating mounts, dovetail to MIL-STD-1913 adaptors, and our universal scope mount for round or straight dovetail airgun receivers here.
<b>APPLICATIONS</b>	<ul style="list-style-type: none"> <li>• HK MR556</li> <li>• HK91/G3 and Clones</li> <li>• Ruger Precision Rifle®</li> </ul>	<ul style="list-style-type: none"> <li>• Direct Impingement AR Platform</li> </ul>	<ul style="list-style-type: none"> <li>• S&amp;W M&amp;P10</li> <li>• DPMS LR-308 and Gen. 2</li> <li>• Armalite AR-10</li> <li>• Clones</li> </ul>	<ul style="list-style-type: none"> <li>• Modern Sporting Rifles</li> <li>• Pistols</li> <li>• Shotguns</li> <li>• AR Pistols</li> <li>• Pistol Caliber Carbines</li> </ul>	<ul style="list-style-type: none"> <li>• Direct Impingement AR Platform</li> </ul>	<ul style="list-style-type: none"> <li>• Fixed A2 Sight and Carry Handle Equipped AR15 and or Stock Configuration Restricted AR15</li> </ul>	<ul style="list-style-type: none"> <li>• USA Made AK and Clones</li> <li>• Romanian/Chinese Made AK and Clones</li> <li>• Yugoslavian Made AK and Clones</li> <li>• Hungarian Made AMD-65 and Clones</li> </ul>	<ul style="list-style-type: none"> <li>• SKS Rifle and Clones</li> <li>• Mosin Nagant Rifles</li> </ul>	<ul style="list-style-type: none"> <li>• Saiga 12 Semi-Auto Shotgun</li> <li>• Mossberg 500 Pump Action Shotgun</li> <li>• Remington 870 Pump Action Shotgun</li> </ul>	<ul style="list-style-type: none"> <li>• M1 Carbine</li> <li>• M1A &amp; M14 Rifles</li> <li>• 10/22® Rifles</li> <li>• Remington 700 Rifles</li> </ul>	<ul style="list-style-type: none"> <li>• MP5 and Clones</li> <li>• G3 Rifles and Clones</li> <li>• G36 Rifles and Clones</li> </ul>	<ul style="list-style-type: none"> <li>• Firearms with MIL-STD-1913 Picatinny</li> <li>• Firearms without MIL-STD-1913 Picatinny</li> </ul>	<ul style="list-style-type: none"> <li>• Airguns with 9mm-11mm Dovetail Rails</li> </ul>
<b>SUGGESTED USES</b>	<ul style="list-style-type: none"> <li>• Sport Shooting &amp; Competition</li> <li>• Long Range Precision</li> <li>• Defense Agencies</li> <li>• Custom Builds</li> <li>• Home and Personal Defense</li> <li>• Recreational</li> </ul>	<ul style="list-style-type: none"> <li>• Sport Shooting &amp; Competition</li> <li>• Custom Builds</li> <li>• Home and Personal Defense</li> <li>• Recreational</li> </ul>	<ul style="list-style-type: none"> <li>• Sport Shooting &amp; Competition</li> <li>• Long Range Precision</li> <li>• Defense Agencies</li> <li>• Custom Builds</li> <li>• Recreational</li> </ul>	<ul style="list-style-type: none"> <li>• Sport Shooting &amp; Competition</li> <li>• Defense Agencies</li> <li>• Custom Builds</li> <li>• Home and Personal Defense</li> <li>• Recreational</li> <li>• Non-magnified Optics Installation</li> <li>• Optics-ready Pistols</li> </ul>	<ul style="list-style-type: none"> <li>• Custom and AR Projects Built from the Ground Up</li> </ul>	<ul style="list-style-type: none"> <li>• Defense Agencies</li> <li>• Custom Builds</li> <li>• Recreational</li> <li>• Home and Personal Defense</li> <li>• Law Enforcement Agencies</li> </ul>	<ul style="list-style-type: none"> <li>• Defense Agencies</li> <li>• Custom Builds</li> <li>• Recreational</li> <li>• Home and Personal Defense</li> </ul>	<ul style="list-style-type: none"> <li>• Long Range Precision</li> <li>• Custom Builds</li> <li>• Recreational</li> <li>• Hunting</li> <li>• 922R Compliance</li> </ul>	<ul style="list-style-type: none"> <li>• Custom Builds</li> <li>• Recreational</li> <li>• Home and Personal Defense</li> <li>• Law Enforcement Agencies</li> <li>• Hunting</li> <li>• 922R Compliance</li> </ul>	<ul style="list-style-type: none"> <li>• Long Range Precision</li> <li>• Custom Builds</li> <li>• Recreational</li> <li>• Home and Personal Defense</li> <li>• Hunting</li> <li>• Plinking</li> </ul>	<ul style="list-style-type: none"> <li>• Custom Builds</li> <li>• Recreational</li> <li>• Home and Personal Defense</li> <li>• Law Enforcement Agencies</li> <li>• Defense Agencies</li> </ul>	<ul style="list-style-type: none"> <li>• Custom Builds</li> <li>• Recreational</li> <li>• Home and Personal Defense</li> <li>• Law Enforcement Agencies</li> <li>• Defense Agencies</li> </ul>	<ul style="list-style-type: none"> <li>• Barrel Droop Compensation</li> <li>• Installation of Dot Sight/Optics</li> <li>• Plinking</li> <li>• Sport Shooting &amp; Competition</li> <li>• Small Game Hunting</li> </ul>





# MR556 | G3 SUPER SLIM RAIL SYSTEMS

- MADE IN USA**
- 6061-T6 ALUMINUM
- PRECISION MACHINED
- AVAILABLE COLOR(S)  
■ Matte Black Anodized

- MR556 Models:**
- MIL-STD-1913 PICATINNY
  - FREE FLOAT
  - OCTAGONAL PROFILE
  - PARTS INCLUDED

- M-LOK® Model:  
8-Slot Picatinny Rail Section & QD Sling Swivel Adaptor
- Keymod Model:  
4-Slot & 8-Slot Picatinny Rail Sections

- Barrel Nut Adaptor
- Installation Hardware

- G3 Model:**
- PARTS INCLUDED

- M-LOK® 8-Slot Picatinny Rail Section & QD Sling Swivel Adaptor
- Installation Hardware

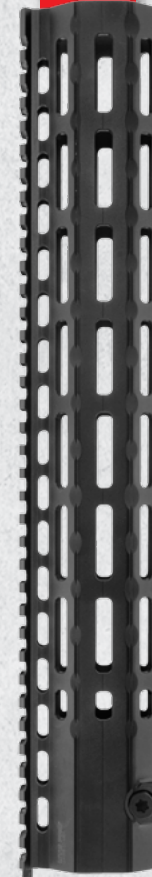

MR556 RAIL

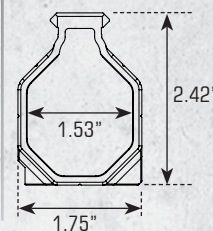

G3 RAIL

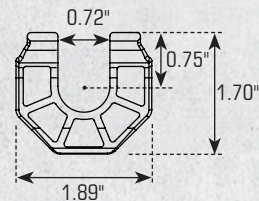

## UTG PRO® MR556 Super Slim Free Float Rail Systems

- Scalloped Top Picatinny Rail Edges for Easy and Snag Free Accessory Mounting
- Super Lightweight with 36 Slot Picatinny Top Rail, Flush Fitting, and Continuous with Flat Top Upper Receiver
- M-LOK®/Keymod Slots on 7 Tracks



## UTG PRO® G3 Super Slim Rail System

- Ergonomic Design with M-LOK® Slots on 5 Tracks
- One-piece Design Compatible with G3/HK91 Rifle and Clones



M-LOK® MTU039SSM  
KEYMOD MTU039SSK

M-LOK® MTU043SSM  
KEYMOD MTU043SSK

Model #	MTU039SSM	MTU039SSK	MTU043SSM
Application	MR556	MR556	G3
Length	14.6"	14.6"	12.0"
M-LOK® / Keymod Slots	49 M-LOK®	105 Keymod	21 M-LOK®
Top Picatinny Slots	36	36	N/A
Net Weight	12.2 oz	12.1 oz	11.3 oz



# RUGER PRECISION RIFLE® SUPER SLIM FREE FLOAT RAIL SYSTEMS

- MADE IN USA**
- 6061-T6 ALUMINUM
- PRECISION MACHINED
- MIL-STD-1913 PICATINNY
- OCTAGONAL PROFILE
- FREE FLOAT
- US PAT. 8806792
- DIMENSION

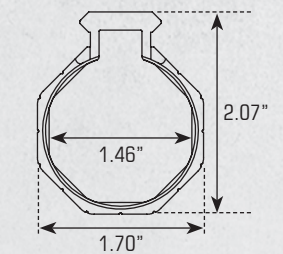

- AVAILABLE COLOR(S)  
■ Matte Black Anodized

- PARTS INCLUDED**

- M-LOK® Model:  
8-Slot Picatinny Rail Section & QD Sling Swivel Adaptor
- Keymod Model:  
4-Slot & 8-Slot Picatinny Rail Sections

- Barrel Nut, Locking Ring, and Barrel Nut Wrench
- Installation Hardware

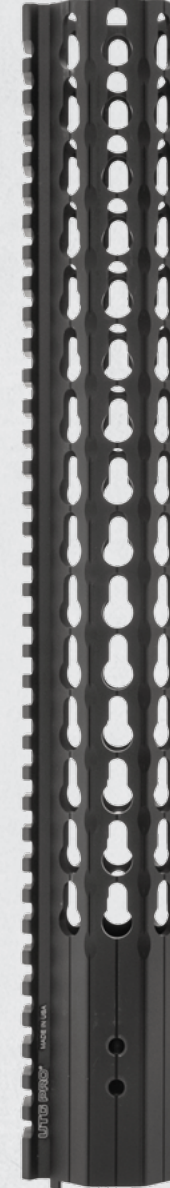

## UTG PRO® Ruger Precision Rifle® Super Slim Free Float Rail Systems

- M-LOK®/Keymod Slots on 7 Tracks
- Super Lightweight with 36 Slot Picatinny Top Rail, Flush Fitting, and Continuous with Receiver



Scalloped Top Picatinny Rail Edges for Snag Free Accessory Mounting

Ergonomic Finger Grooves for a Solid and Comfortable Grip

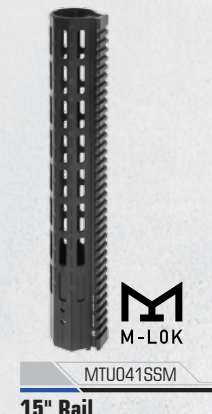

15" Rail



15" Rail



Flush Fitting and Continuous with Receiver



Integral Anti-rotation Tabs for Accurate Alignment with Receiver

Model #	MTU041SSM	MTU041SSK
Length	15.0"	15.0"
M-LOK® / Keymod Slots	49 M-LOK	105 Keymod
Top Picatinny Slots	36	36
Net Weight	19.1 oz	18.5 oz





# AR15 ULTRA SLIM FREE FLOAT M-LOK® RAIL SYSTEMS

- MADE IN USA**
- 6061-T6 ALUMINUM
- PRECISION MACHINED
- MIL-STD-1913 PICATINNY
- OCTAGONAL PROFILE
- FREE FLOAT
- US PAT. 8806792
- DIMENSION

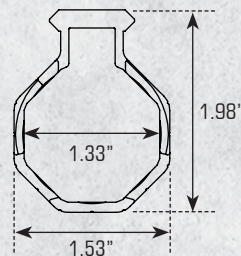

**AVAILABLE COLOR(S)**

■ Matte Black Anodized

**PARTS INCLUDED**

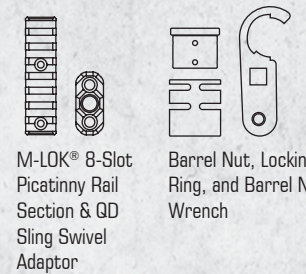

## UTG PRO® AR15 Ultra Slim Free Float M-LOK® Rail Systems

- Ultra Slim Design with Lightening Cuts Made Throughout the Handguard to Massively Reduce Weight, While Still Allowing for a High Level of Modularity
- Ergonomically Grooved Handguard Surface and Octagonal Profile Features Left and Right Side Grip Serrations
- Simple and User Friendly Installation



MTU019SSM3T Includes a Lightweight Titanium Barrel Nut (TLUBN01) 40% Lighter than Standard Steel Barrel Nut  
[Also Refer to P.067]

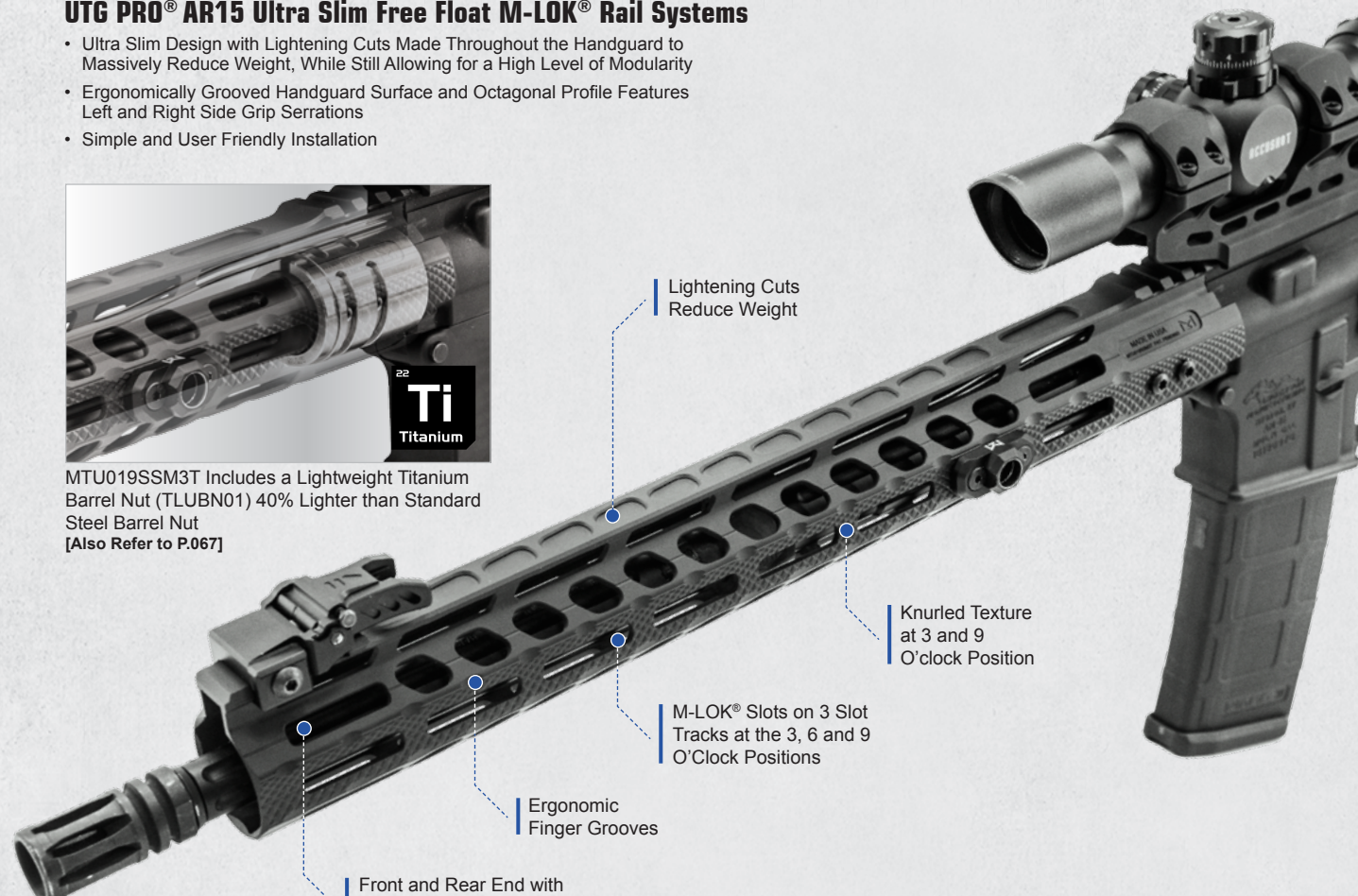

Lightening Cuts Reduce Weight

Knurled Texture at 3 and 9 O'clock Position

M-LOK® Slots on 3 Slot Tracks at the 3, 6 and 9 O'Clock Positions

Ergonomic Finger Grooves

Front and Rear End with M-LOK® Slots at the 1, 5, 7 and 9 O'Clock Positions



3-Slot Top Picatinny Rail Found at the Front and Rear of the Handguard



Compatible with Left or Right Handed Standard Mil-spec AR15 Upper Receivers



Integral Anti-rotation Tabs for Accurate Alignment with Upper Receiver



Flush Fitting and Continuous with Upper Receiver



## Additional Accessories Available



### UTG PRO® Super Slim Free Float Titanium Barrel Nut

- Precision Machined from Grade 5 Titanium
- Weight 1.8 oz, 40% Lighter than Standard Steel Barrel Nut
- Compatible with UTG PRO® USA Made AR15 Super Slim Free Float Handguards Only



## Additional M-LOK® Accessories Available



MT-AFGM01  
**M-LOK® Angled Foregrip**  
[Also Refer to P. 148]



TL-TRM01  
**M-LOK® Angled Index Mount**  
[Also Refer to P. 148]



MT-FGM01  
**M-LOK® Super Slim Aluminum Vertical Foregrip**  
[Also Refer to P. 150]



TL-HSM01  
**M-LOK® Ultra Slim Hand Stop**  
[Also Refer to P. 149]



RB-HP30MB (4/PACK)  
**Low Profile M-LOK® Rail Panel Covers**  
[Also Refer to P. 153]



TLUSW001  
TLUSW001D  
**UTG PRO® M-LOK® QD Sling Swivel Adaptor**  
[Also Refer to P. 156]



MTU019SSM3T  
**15" Rail Titanium Barrel Nut**



MTU019SSM3  
**15" Rail Steel Barrel Nut**



Model #	MTU019SSM3T	MTU019SSM3
Length	15.3"	15.3"
M-LOK® Slots	24	24
Top Picatinny Slots	6	6
Net Weight	10.0 oz	11.5 oz





# AR15 SUPER SLIM FREE FLOAT M-LOK® RAIL SYSTEMS

MOUNTING SYSTEMS

AR15 SUPER SLIM FREE FLOAT M-LOK® RAILS

- MADE IN USA
- 6061-T6 ALUMINUM
- PRECISION MACHINED
- MIL-STD-1913 PICATINNY
- OCTAGONAL PROFILE
- FREE FLOAT
- US PAT. 8806792
- DIMENSION

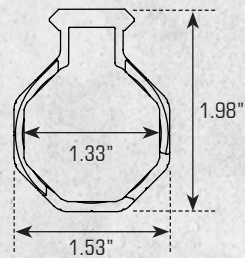

- AVAILABLE COLOR(S)
  - Matte Black Anodized
  - FDE Cerakote®
- PARTS INCLUDED

- M-LOK® 8-Slot Picatinny Rail Section & QD Sling Swivel Adaptor
- Barrel Nut, Locking Ring, and Barrel Nut Wrench
- Installation Hardware



## UTG PRO® AR15 Super Slim Free Float M-LOK® Rail Systems

- Ergonomic Octagonal Profile with Grooved Surface for a Solid and Comfortable Grip
- M-LOK® Slots on 7 Tracks



Scalloped Top Picatinny Rail Edges for Snag Free Accessories Mounting

Ergonomic Finger Grooves for a Solid and Comfortable Grip



Traditional Handguard Super Slim Handguard  
Super Slim Design for Comfort and Weight Reduction



Flush Fitting and Continuous with Upper Receiver



Integral Anti-rotation Tabs for Accurate Alignment with Upper Receiver



### Additional M-LOK® Accessories Available



TL-HSM01  
M-LOK® Ultra Slim Hand Stop  
[Also Refer to P. 149]



TL-TRM01  
M-LOK® Angled Index Mount  
[Also Refer to P. 148]



RB-HP30MB (4/PACK)  
Low Profile M-LOK® Rail Panel Covers  
[Also Refer to P. 153]

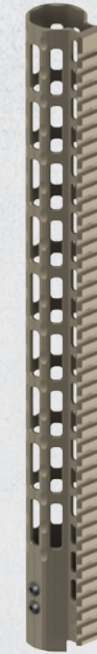

MTU037SSM  
MTU037SSMD  
17" Rail



MTU019SSM  
MTU019SSMD  
15" Rail

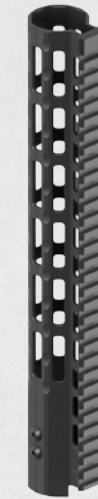

MTU006SSM  
MTU006SSMD  
13" Rail



MTU025SSM  
10" Rail



MTU008SSM  
5.5" Rail

Model #	MTU037SSM	MTU019SSM	MTU006SSM	MTU025SSM	MTU008SSM
Length	17.3"	15.3"	12.9"	10.3"	5.5"
M-LOK® Slots	63	56	42	35	14
Top Picatinny Slots	42	37	31	25	13
Net Weight	13.8 oz	12.5 oz	11.2 oz	10.2 oz	7.3 oz

MOUNTING SYSTEMS

AR15 SUPER SLIM FREE FLOAT M-LOK® RAILS





# AR15 SUPER SLIM FREE FLOAT KEYMOD RAIL SYSTEMS

MOUNTING SYSTEMS

AR15 SUPER SLIM FREE FLOAT KEYMOD RAILS

- MADE IN USA**
- 6061-T6 ALUMINUM
- PRECISION MACHINED
- MIL-STD-1913 PICATINNY
- OCTAGONAL PROFILE
- FREE FLOAT
- US PAT. 8806792
- DIMENSION

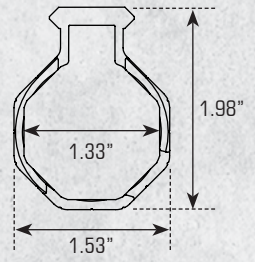

- AVAILABLE COLOR(S)**
- Matte Black Anodized
  - FDE Cerakote®
  - OD Green Cerakote®
  - Gun Metal Cerakote®
  - Burnt Bronze Cerakote®

**PARTS INCLUDED**

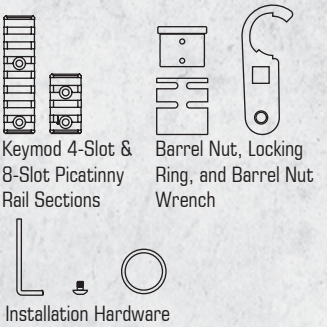

## UTG PRO® AR15 Super Slim Free Float Keymod Rail Systems

- Ergonomic Octagonal Profile with Grooved Surface for a Solid and Comfortable Grip
- Keymod Slots on 7 Tracks

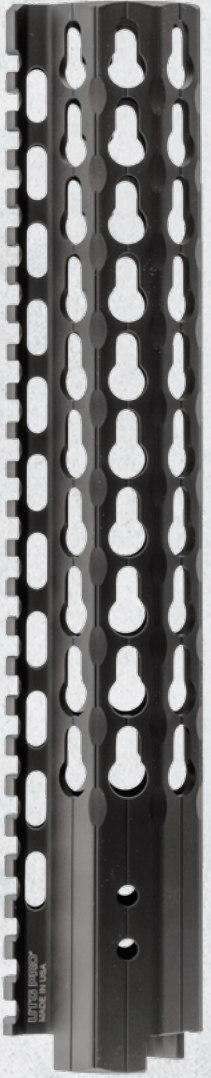

Scalloped Top Picatinny Rail Edges for Snag Free Accessories Mounting

Ergonomic Finger Grooves for a Solid and Comfortable Grip



Super Slim Design for Comfort and Weight Reduction



Flush Fitting and Continuous with Upper Receiver



Integral Anti-rotation Tabs for Accurate Alignment with Upper Receiver

MOUNTING SYSTEMS

AR15 SUPER SLIM FREE FLOAT KEYMOD RAILS



### Additional Keymod Accessories Available

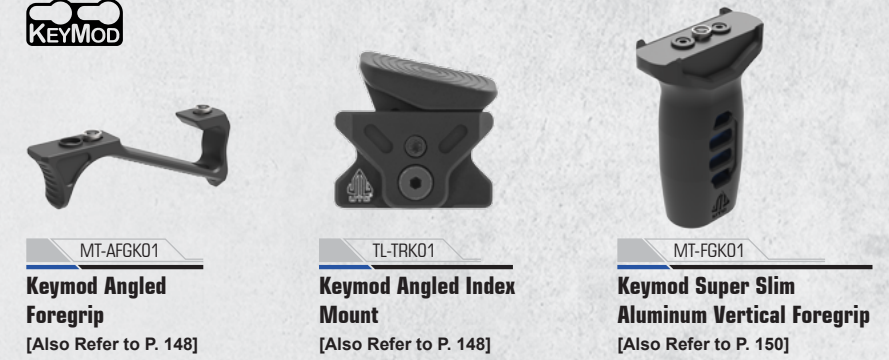

	MTU037SSK MTU037SSKD <b>17" Rail</b>	MTU019SSK MTU019SSKD MTU019SSKG MTU019SSKM MTU019SSKZ <b>15" Rail</b>	MTU006SSK <b>13" Rail</b>	MTU025SSK <b>10" Rail</b>	MTU004SSK <b>9" Rail</b>	MTU005SSK <b>7" Rail</b>	MTU008SSK <b>5.5" Rail</b>
--	--	--	------------------------------	------------------------------	-----------------------------	-----------------------------	-------------------------------

Model #	MTU037SSK	MTU019SSK	MTU006SSK	MTU025SSK	MTU004SSK	MTU005SSK	MTU008SSK
Length	17.3"	15.3"	12.9"	10.3"	9.6"	7.2"	5.5"
Keymod Slots	126	112	91	70	63	42	28
Top Picatinny Slots	42	37	31	25	23	18	13
Net Weight	13.1 oz	11.9 oz	10.5 oz	9.7 oz	9.1 oz	8.1 oz	7.2 oz



# AR15 2-TONE SUPER SLIM FREE FLOAT M-LOK® | KEYMOD RAIL SYSTEMS

# AR15 SUPER SLIM FREE FLOAT RAIL SYSTEMS

MOUNTING SYSTEMS

AR15 2-TONE SUPER SLIM FREE FLOAT RAILS

- MADE IN USA**
- 6061-T6 ALUMINUM
- MIL-STD-1913 PICATINNY
- OCTAGONAL PROFILE
- FREE FLOAT
- US PAT. 8806792
- DIMENSION

## 2-TONE

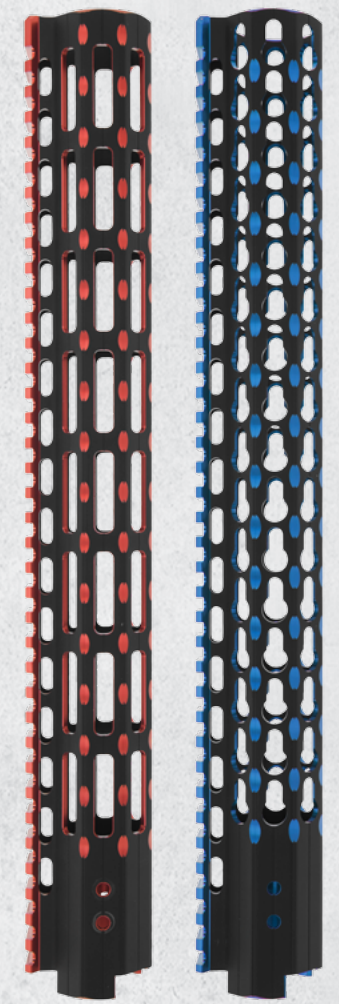

### UTG PRO® AR15 2-Tone Super Slim Free Float M-LOK® | Keymod Rail Systems

- Ergonomic Octagonal Profile with Grooved Surface for a Solid and Comfortable Grip
- M-LOK®/Keymod Slots on 7 Tracks

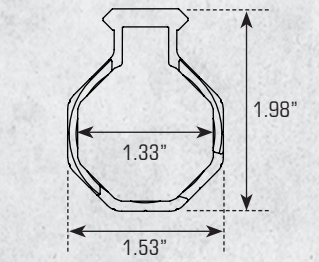

#### AVAILABLE COLOR(S)

- Black/Red Anodized
- Black/Blue Anodized
- Black/Bronze Anodized

#### PARTS INCLUDED

- M-LOK® Models: 8-Slot Picatinny Rail Section & QD Sling Swivel Adaptor
- Keymod Models: 4-Slot & 8-Slot Picatinny Rail Sections
- Barrel Nut, Locking Ring, and Barrel Nut Wrench
- Installation Hardware



- MTU019SSMR2
- MTU019SSMB2
- MTU019SSMZ2

#### 15" RAIL

Model #	MTU019SSMR2 / MB2 / MZ2	MTU019SSKR2 / KB2 / KZ2
Length	15.3"	15.3"
M-LOK® / Keymod Slots	49 M-LOK®	112 Keymod
Top Picatinny Slots	37	37
Net Weight	12.8 oz	12.1 oz



- MTU019SSKR2
- MTU019SSKB2
- MTU019SSKZ2

#### 15" RAIL

#### Additional Color Anodized Accessories Available



#### Ultra Slim Handstops

[Also Refer to P. 149]

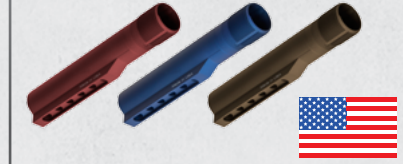

#### UTG PRO® AR15 Mil-Spec 6 Position Receiver Extension Tubes

[Also Refer to P. 138]

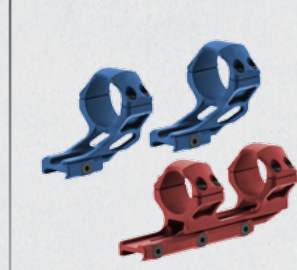

#### ACCU-SYNC® Offset Picatinny Scope Ring Mounts

[Also Refer to P. 050]

- MADE IN USA**
- 6061-T6 ALUMINUM
- PRECISION MACHINED
- MIL-STD-1913 PICATINNY
- TUBULAR PROFILE
- FREE FLOAT
- US PAT. 8806792
- DIMENSION

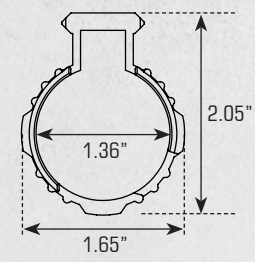

#### AVAILABLE COLOR(S)

- Matte Black Anodized
- FDE Cerakote®

#### PARTS INCLUDED

- 2-Slot Low Profile Picatinny Rail Section x3
- Barrel Nut, Locking Ring, and Barrel Nut Wrench
- Installation Hardware

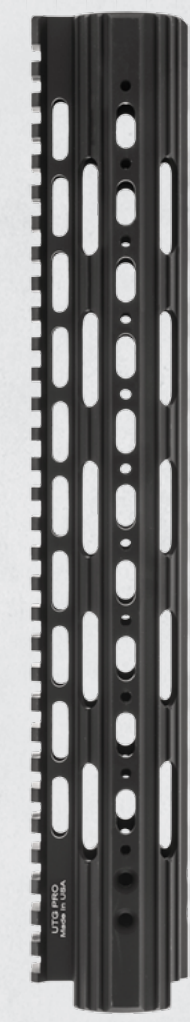

### UTG PRO® AR15 Super Slim Free Float Rail Systems

- Super Slim, Compact Design with Precision Steel Barrel Nut



Scalloped Top Picatinny Rail Edges for Snag Free Accessories Mounting

3 Slot Tracks at the 3, 6 and 9 O'Clock Positions

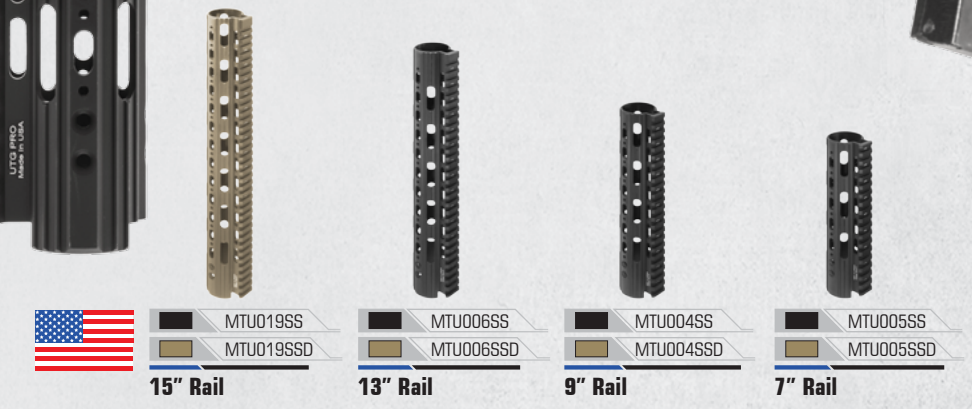

Model #	MTU019SS	MTU006SS	MTU004SS	MTU005SS
Length	15.3"	12.9"	9.6"	7.5"
Top Picatinny Slots	37	31	23	18
Net Weight	13.4 oz	12.0 oz	9.7 oz	8.4 oz

#### Additional Accessories Available

For Super Slim Free Float Rail Systems Only

#### UTG PRO® Low Profile Picatinny Rail Sections

- Matte Black Anodized or Cerakote® Finish

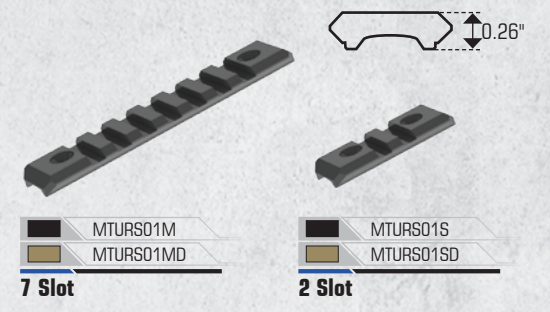

#### UTG PRO® Picatinny Rail Sections

- Continuous Rail Edge
- Matte Black Anodized or Cerakote® Finish

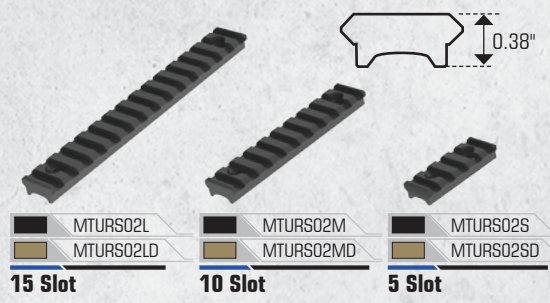

MOUNTING SYSTEMS

AR15 SUPER SLIM FREE FLOAT RAILS





# AR15 DROP-IN SUPER SLIM RAIL SYSTEMS



MADE IN USA



6061-T6 ALUMINUM



MIL-STD-1913 PICATINNY



DROP-IN



AVAILABLE COLOR(S)

Matte Black Anodized

**M-LOK® / Keymod**  
Drop-in Super Slim Rails:



PATENT PENDING



OCTAGONAL PROFILE



DIMENSION

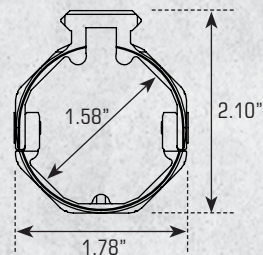

**Drop-in Super Slim Rails:**



US PAT. D711492



TUBULAR PROFILE



DIMENSION

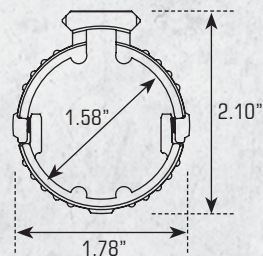

**15" RAIL CARBINE LENGTH INSTALL HANDGUARD**

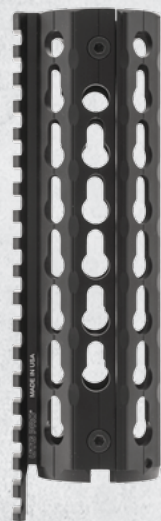

**7" RAIL CARBINE LENGTH**

## UTG PRO® AR15 Drop-In Super Slim Rail Systems

- Fits Carbine Length AR15 with Standard Barrel Nut/Delta Ring Assembly and Round Front Handguard Cap and Ruger AR556
- M-LOK® Drop-in Super Slim Handguards Include 2 M-LOK® Accessories, an 8 Slot Picatinny Rail Section and a QD Sling Swivel Adaptor
- Keymod Drop-in Super Slim Handguards Include One 4 and 8 Slot Keymod Picatinny Rail Section
- Drop-in Super Slim Handguards Include 4 Rail Sections: Two 2 Slot and Two 4 Slot



Top Rail Extends to Form a Continuous Picatinny Flat Top

Scalloped Top Picatinny Rail Edges for Snag Free Accessories Mounting



Fits Carbine Length AR15 with Standard Barrel Nut / Delta Ring Assembly and Round Front Handguard Cap and Ruger AR556

Extended Drop-in Design with Cutout for Standard A2 Front Sight (MTU015SSM / MTU015SSK / MTU015SS Only)



15 INCH MTU015SSM  
7 INCH MTU001SSM

**M-LOK® Drop-In Super Slim Rails**

15 INCH MTU015SSK  
7 INCH MTU001SSK

**Keymod Drop-In Super Slim Rails**

15 INCH MTU015SS  
7 INCH MTU001SS

**Drop-In Super Slim Rails**

Model #	MTU015SSM	MTU001SSM	MTU015SSK	MTU001SSK	MTU015SS	MTU001SS
Length	15.0"	7.3"	15.0"	7.3"	15.0"	7.3"
M-LOK/Keymod Slots	45 M-LOK	24 M-LOK	89 Keymod	45 Keymod	N/A	N/A
Top Picatinny Slots	31	18	31	18	32	18
Net Weight	12.4 oz	6.2 oz	12.2 oz	9.0 oz	14.1 oz	6.9 oz

## Additional Accessories Available



M-LOK MT-AFGM01  
KEYMOD MT-AFGK01

**M-LOK®/Keymod Angled Foregrips**  
[Also Refer to P. 148]



M-LOK MT-FGM01  
KEYMOD MT-FGK01

**M-LOK®/Keymod Super Slim Aluminum Vertical Foregrips**  
[Also Refer to P. 150]



M-LOK TL-TRM01  
KEYMOD TL-TRK01

**M-LOK®/Keymod Angled Index Mounts**  
[Also Refer to P. 148]



M-LOK TL-HSM01  
KEYMOD TL-HSK01

**M-LOK®/Keymod Ultra Slim Hand Stops**  
[Also Refer to P. 149]



## UTG PRO® Rail Sections

- For Drop-in Super Slim Rail Systems Only
- Matte Black Anodized



2 Slot  
MTURS03S



4 Slot  
MTURS03M







# AR15 DROP-IN QUAD RAIL SYSTEMS



MADE IN USA



6061-T6 ALUMINUM



PRECISION MACHINED



MIL-STD-1913 PICATINNY



AVAILABLE COLOR(S)

Matte Black Anodized

Army Digital Pixedized

## UTG PRO® AR15 Drop-In Quad Rail Systems

- Durable Finishes Provide Excellent Resistance to Corrosion and Wear
- Great Zero-retention for All Accessories Installed on Rails



MTU001

MTU001R

### UTG PRO® AR15 Drop-In Carbine Length Quad Rail

- 2-piece Design with Alignment Housing for a Perfect Fit with the Standard Barrel Nut/Delta Ring Assembly and Round Front Handguard Cap



For Use with Round Front Handguard Cap



12 Pc. Rubber Rail Guards Included



MTU001T

### UTG PRO® AR15 Drop-In Carbine Length Quad Rail with Continuous Top Rail

- Extended Top Rail Provides a Continuous Unimpeded Flat Top
- 2-piece Design with Alignment Housing for a Perfect Fit with the Standard Barrel Nut/Delta Ring Assembly and Round Front Handguard Cap



Extended Top Rail Provides a Continuous Unimpeded Flat Top



For Use with Round Front Handguard Cap



12 Pc. Rubber Rail Guards Included

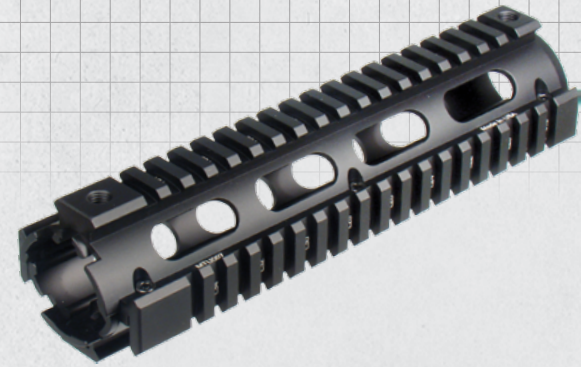

MTU007

### UTG PRO® AR15 Drop-In Mid-Length Quad Rail

- 2-piece Design with Integral Spinal Cords/Alignment Housing for Precise Fit
- Designed to be Compatible with Standard Triangular Front Handguard Cap



For Use with Triangular Front Handguard Cap



18 Pc. Rubber Rail Guards Included



MTU015

### UTG PRO® AR15 Drop-In Carbine Length Quad Rail with Forward Extension

- 3-piece Design with Integral Spinal Cords/Alignment Housing for a Perfect Fit with the Standard Barrel Nut/Delta Ring Assembly and Round Front Handguard Cap
- Designed with Cutout to Accommodate Front Sight, Sling Swivel, and Bayonet Lug



For Use with Round Front Handguard Cap



18 Pc. Rubber Rail Guards Included



## Additional Accessories Available

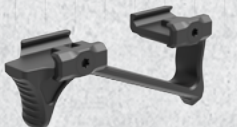

MT-AFGP01

**Picatinny Angled Foregrip**  
[Also Refer to P. 148]



MT-FGP01

**Picatinny Super Slim Aluminum Vertical Foregrip**  
[Also Refer to P. 150]

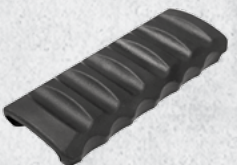

RB-HP27B (6/PACK)

**Low Profile Picatinny Panel Covers**  
[Also Refer to P. 153]



TL-SWPM01

**Low Profile Angled QD Sling Swivel Picatinny Adaptor**  
[Also Refer to P. 156]

Model #	MTU001 / MTU001R	MTU001T	MTU007	MTU015
Length	6.7"	7.3"	8.7"	10.7"
Top / Bottom / Left / Right Picatinny Slots	T:14 / B:14 / L:14 / R:14	T:18 / B:17 / L:16 / R:16	T:18 / B:18 / L:18 / R:18	T:19 / B:22 / L:25 / R:25
Net Weight	11.3 oz	11.3 oz	14.7 oz	17.1 oz





# AR308 SUPER SLIM FREE FLOAT M-LOK® RAIL SYSTEMS

- MADE IN USA**
- 6061-T6 ALUMINUM
- PRECISION MACHINED
- MIL-STD-1913 PICATINNY
- OCTAGONAL PROFILE
- FREE FLOAT
- US PAT. 8806792
- AVAILABLE COLOR(S)  
■ Matte Black Anodized
- PARTS INCLUDED



## UTG PRO® AR308 Super Slim Free Float M-LOK® Rail Systems

- 4 Versions with Included Precision Steel Barrel Nut to Fit Specific Models and Clones (See Details Below)
- Ergonomic Octagonal Profile with M-LOK® Slots on 7 Tracks

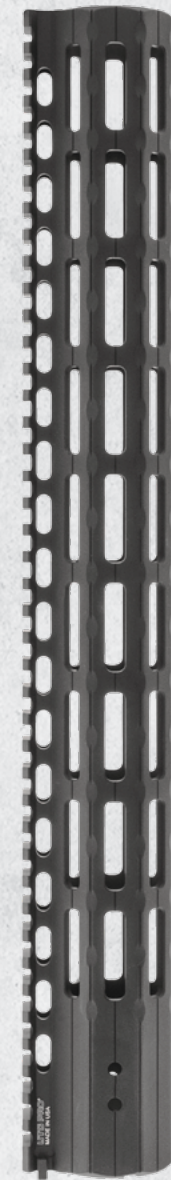

Scalloped Top Picatinny Rail Edges for Snag Free Accessories Mounting

Ergonomic Finger Grooves for a Solid and Comfortable Grip

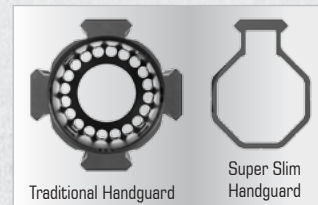
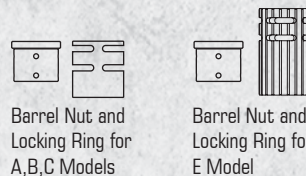
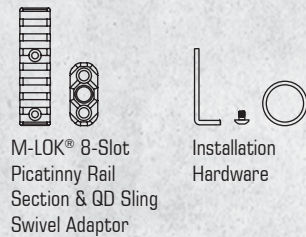

Super Slim Design for Comfort and Weight Reduction



Flush Fitting and Continuous with Upper Receiver



Integral Anti-rotation Tabs for Accurate Alignment with Upper Receiver

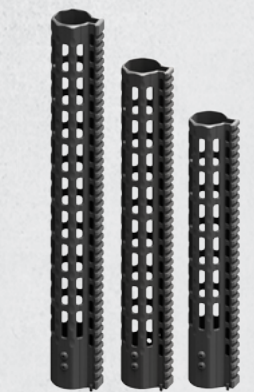

- 13 INCH MTU020SSMB
- 15 INCH MTU026SSMB
- 17 INCH MTU038SSMB

### DPMS LR-308 High Profile

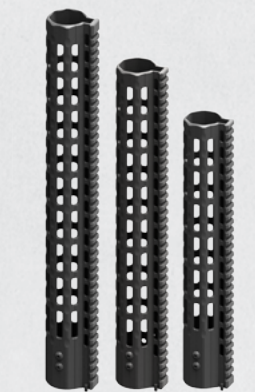

- 13 INCH MTU020SSMC
- 15 INCH MTU026SSMC
- 17 INCH MTU038SSMC

### S&W M&P10 / DPMS LR-308 Low Profile

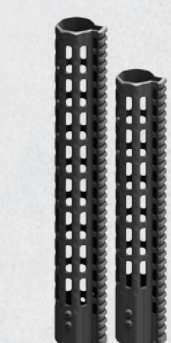

- 13 INCH MTU020SSME
- 15 INCH MTU026SSME

### DPMS Gen II



- 15 INCH MTU026SSMA

### ARMALITE® AR-10



## Additional M-LOK® Accessories Available



MT-AFGM01  
**M-LOK® Angled Foregrip**  
[Also Refer to P. 148]

RB-HP30MB (4/PACK)  
**Low Profile M-LOK® Rail Panel Covers**  
[Also Refer to P. 153]

Medium Profile TL-BPDM01  
High Profile TL-BPDM02  
**M-LOK® Recon Flex™ Bipods**  
[Also Refer to P. 106]

Model #	MTU020SSMB MTU020SSMC MTU020SSME	MTU026SSMA MTU026SSMB MTU026SSMC MTU026SSME	MTU038SSMB MTU038SSMC
Length	12.7"	15.1"	17.1"
M-LOK® Slots	42	56	63
Top Picatinny Slots	31	37	42
Net Weight	Model B - 14.2 oz Model C - 14.0 oz Model E - 14.7 oz	Model A&B - 15.8 oz Model C - 15.5 oz Model E - 16.3 oz	Model B - 17.4 oz Model C - 17.1 oz Model E - 18.0 oz

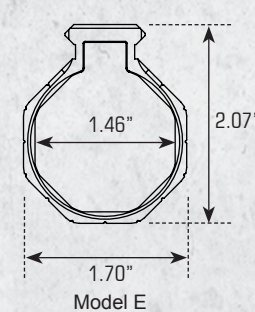
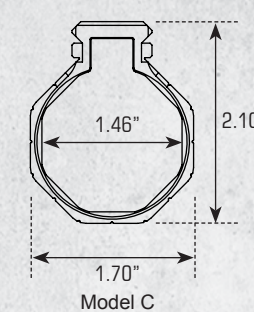
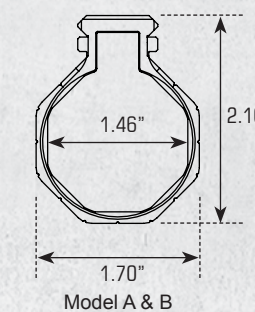





# AR308 SUPER SLIM FREE FLOAT KEYMOD RAIL SYSTEMS

- MADE IN USA**
- 6061-T6 ALUMINUM
- PRECISION MACHINED
- MIL-STD-1913 PICATINNY
- OCTAGONAL PROFILE
- FREE FLOAT
- US PAT. 8806792
- AVAILABLE COLOR(S)  
■ Matte Black Anodized
- PARTS INCLUDED

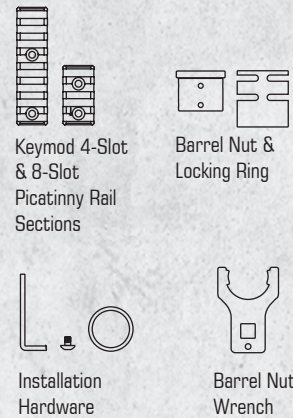

## UTG PRO® AR308 Super Slim Free Float Keymod Rail Systems

- 3 Versions with Included Precision Steel Barrel Nut to Fits Specific Models and Clones (See Details Below)

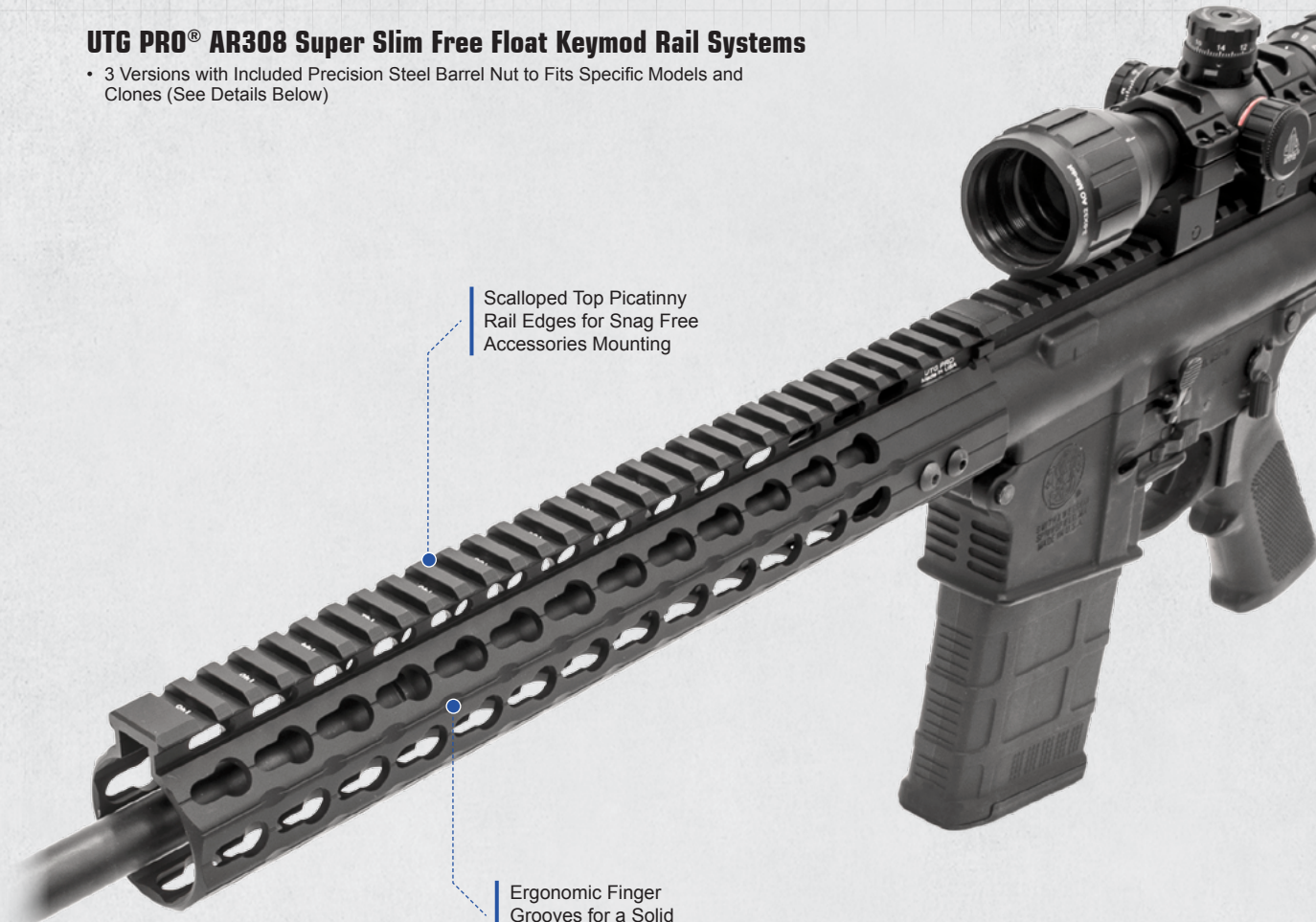
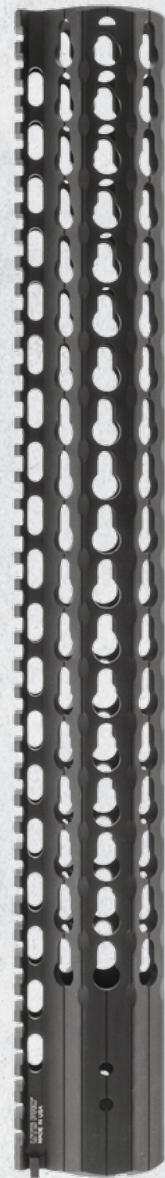

Scalloped Top Picatinny Rail Edges for Snag Free Accessories Mounting

Ergonomic Finger Grooves for a Solid and Comfortable Grip



Super Slim Design for Comfort and Weight Reduction



Flush Fitting and Continuous with Upper Receiver



Integral Anti-rotation Tabs for Accurate Alignment with Upper Receiver

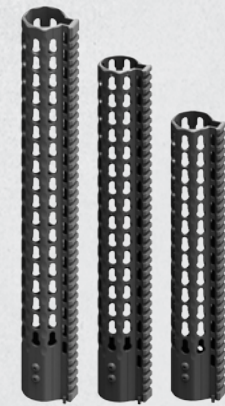

- 13 INCH MTU020SSKB
- 15 INCH MTU026SSKB
- 17 INCH MTU038SSKB

**DPMS LR-308 High Profile**

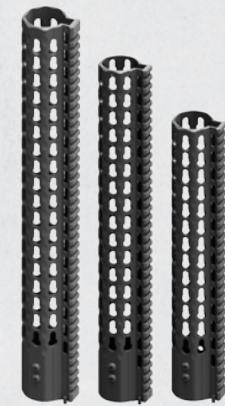

- 13 INCH MTU020SSKC
- 15 INCH MTU026SSKC
- 17 INCH MTU038SSKC

**S&W M&P10 / DPMS LR-308 Low Profile**



- 15 INCH MTU026SSKA

**ARMALITE® AR-10**

## Additional Keymod Accessories Available



TLUSW002  
**UTG PRO® Keymod QD Sling Swivel Adaptors**  
[Also Refer to P. 156]



MT-FGK01  
**Keymod Super Slim Aluminum Vertical Foregrip**  
[Also Refer to P. 150]



RB-HP25B (4/PACK)  
**Low Profile Keymod Rail Panel Covers**  
[Also Refer to P. 153]

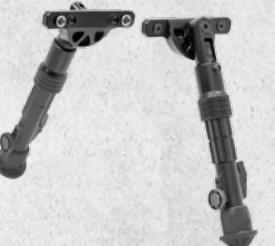

Medium Profile TL-BPDK01  
High Profile TL-BPDK02  
**Keymod Recon Flex™ Bipods**  
[Also Refer to P. 106]



Model #	MTU020SSKB MTU020SSKC	MTU026SSKA MTU026SSKB MTU026SSKC	MTU038SSKB MTU038SSKC
Length	12.7"	15.1"	17.1"
Keymod Slots	91	112	126
Top Picatinny Slots	31	37	42
Net Weight	Model B -13.5 oz Model C -13.2 oz	Model A&B -14.9 oz Model C -14.4 oz	Model B -17.8 oz Model C -17.6 oz

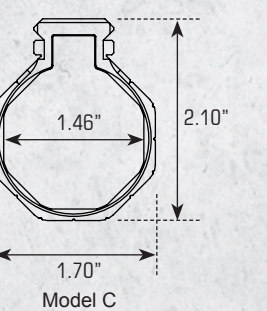
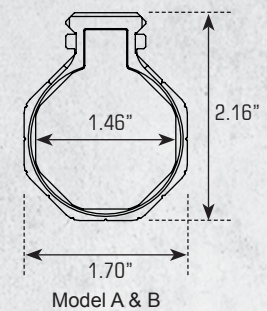





# AR308 SUPER SLIM FREE FLOAT RAIL SYSTEMS

- MADE IN USA**
- 6061-T6 ALUMINUM
- PRECISION MACHINED
- MIL-STD-1913 PICATINNY
- TUBULAR PROFILE
- FREE FLOAT
- US PAT. 8806792
- AVAILABLE COLOR(S)  
■ Matte Black Anodized
- PARTS INCLUDED

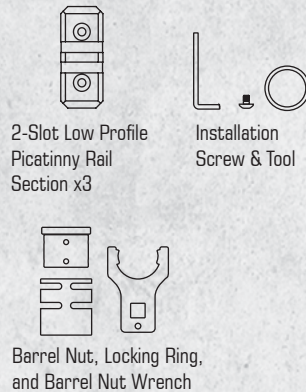

## UTG PRO® AR308 Super Slim Free Float Rail Systems

- 3 Versions with Included Precision Steel Barrel Nut to Fits Specific Models and Clones (See Details Below)
- Lightweight Continuous with Upper Receiver
- Includes 3 User Configurable 2 Slot Rail Sections

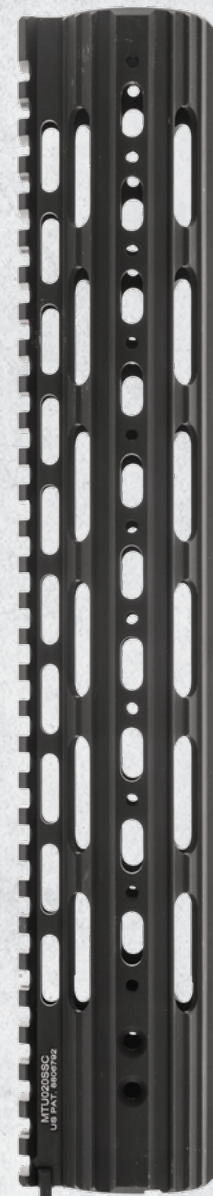

MTU020SSA

### ARMALITE® AR-10

MTU020SSB

### DPMS LR-308 High Profile

MTU020SSC

### S&W M&P10 / DPMS LR-308 Low Profile

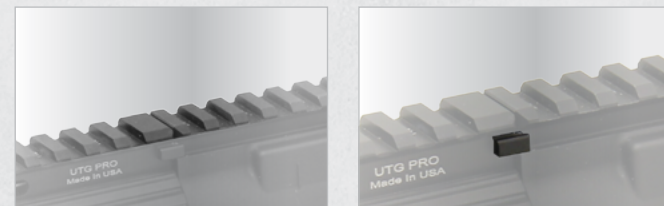
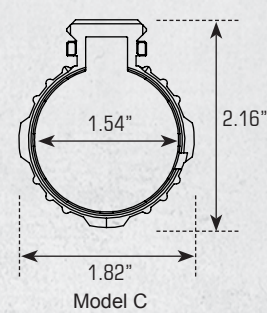
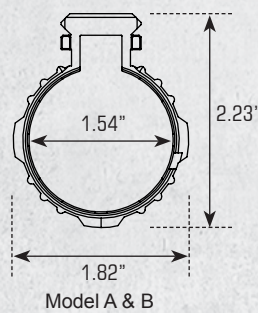

Model #	MTU020SSA	MTU020SSB	MTU020SSC
Length	12.7"	12.7"	12.7"
Top Picatinny Slots	31	31	31
Net Weight	14.7 oz	14.7 oz	14.0 oz

## Additional Accessories Available

For Super Slim Free Float Rail Systems Only

### UTG PRO® Low Profile Picatinny Rail Section

- Matte Black Anodized or Cerakote® Finish

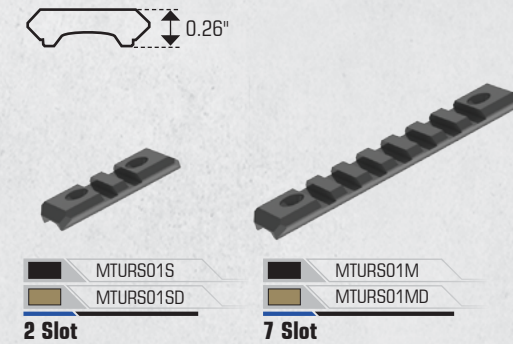

### UTG PRO® Picatinny Rail Section

- Continuous Rail Edge Design for Optimal Accessory Attachment
- Matte Black Anodized or Cerakote® Finish

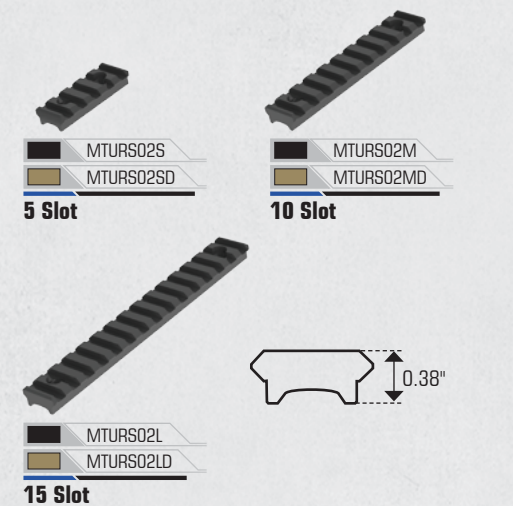

# AR308 DROP-IN QUAD RAIL

- MADE IN USA**
- 6061-T6 ALUMINUM
- PRECISION MACHINED
- MIL-STD-1913 PICATINNY
- DROP-IN
- QUAD RAIL
- DIMENSION
- AVAILABLE COLOR(S)  
■ Matte Black Anodized

## UTG PRO® AR308 Drop-In Mid Length Quad Rail

- Compatible with Smith & Wesson M&P10 and Clones

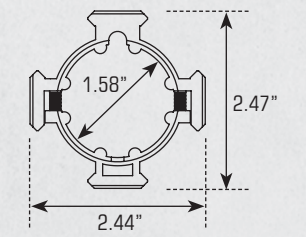

- AVAILABLE COLOR(S)  
■ Matte Black Anodized

Model #	MTU018
Length	8.7"
Top / Bottom / Left /Right Picatinny Slots	T:19 / B:19 / L:19 / R:19
Net Weight	14.7 oz



9 INCH MTU018 S&W M&P10



For Use with Round Front Handguard Cap



16 Pc. Rubber Rail Guards Included





# RDM20 REFLEX MICRO DOT SUPER SLIM MOUNTS

6061-T6 ALUMINUM

PRECISION MACHINED

AVAILABLE COLOR(S)

Matte Black Anodized

RDM-2045 & RDM-20AC:

MIL-STD-1913 PICATINNY

RDM-20GL, RDM-20SIG, & RDM-20SW:

REAR SIGHT DOVETAIL

RDM20

NEW

## RDM20 Reflex Micro Dot Super Slim Mounts

- Lightening Cuts Reduce Overall Weight (Excludes Dovetail Models)



Utilizes Locking Torx Screws and Square-shaped Integral Recoil Stops for a Secure Zero Hold (RDM-20GL, RDM-20SIG, and RDM-20SW)



Utilizes Locking Torx Screws and Steel Dovetail Insert for a Secure Zero Hold (RDM-20GL, RDM-20SIG, and RDM-20SW)

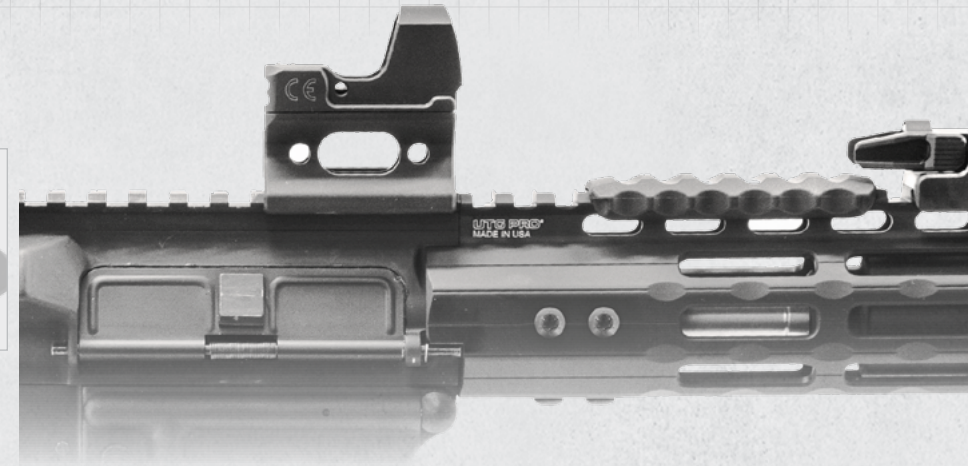

RDM20 RDM-2045  
45 Degree Angled Mount

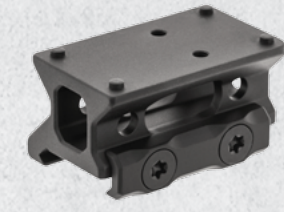

RDM20 RDM-20AC  
Absolute Co-Witness Mount

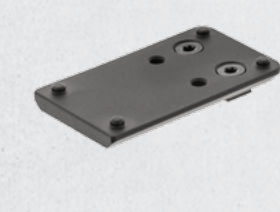

RDM20 RDM-20GL  
Glock Double Stack Rear Sight Mount



RDM20 RDM-20SIG  
SIG P-Series Double Stack Rear Sight Mount

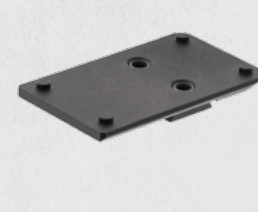

RDM20 RDM-20SW  
S&W M&P Double Stack Rear Sight Mount



RED DOT SCP-RDM20R  
GREEN DOT SCP-RDM20G

## Reflex Micro Dot

- 4 MOA Illuminated Single Dot with 6 Variable Brightness Settings
  - 1-Click Illumination Memory Feature Gets the User Right Back to the Brightness Setting Last Used
  - Windage and Elevation Adjustable with 1 MOA/Click Adjustment at 100 Yds
  - Adaptive Mount Base Includes Universal MIL-STD-1913 Picatinny Mount and is Compatible with Glock MOS #1, #5, S&W CORE™ #5 Plates, and Other Equivalently Manufactured Plates
- [Also Refer to P. 040]**



Model #	RDM-2045	RDM-20AC	RDM-20GL	RDM-20SIG	RDM-20SW
Length / Width	1.8" / 2.5"	1.8" / 1.1"	1.8" / 1.1"	1.8" / 1.1"	1.8" / 1.1"
Saddle Height	N/A	0.78"	0.15"	0.16"	0.16"
Weight	1.5 oz	1.5 oz	0.5 oz	0.5 oz	0.5 oz



# RMR® | T1 | MRO® SUPER SLIM MOUNTS

6061-T6 ALUMINUM

PRECISION MACHINED

AVAILABLE COLOR(S)

Matte Black Anodized

All Models (Excludes MT-RMRGL):

MIL-STD-1913 PICATINNY

MT-RMRGL:

REAR SIGHT DOVETAIL

RMR

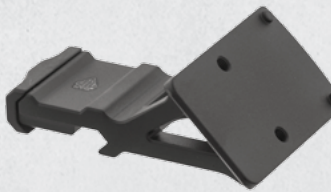

RMR MT-RMR45  
45 Degree Angled Mount

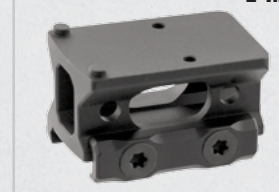

RMR MT-RMRAC  
Absolute Co-Witness Mount



RMR MT-RMRXS  
Low Profile Mount



RMR MT-RMR13C  
Lower 1/3 Co-Witness Mount



RMR MT-RMRGL  
Glock Double Stack Rear Sight Mount

## RMR® | T1 | MRO® Super Slim Mounts

- Utilizes Locking Torx Screws and Square-shaped Integral Recoil Stops or Rear Sight Dovetail Insert for a Secure Zero Hold
- Significant Lightening Cuts Reduce Overall Weight and Bulk (Excludes Low Profile and Dovetail Models)



45 Degree Angled



Lower 1/3 Co-Witness



Absolute Co-Witness



Low Profile



Rear Sight Dovetail

T1



T1 MT-T1AC  
Absolute Co-Witness Mount



T1 MT-T113C  
Lower 1/3 Co-Witness Mount

MRO



MRO MT-MROAC  
Absolute Co-Witness Mount



MRO MT-MRO13C  
Lower 1/3 Co-Witness Mount



MRO MT-MROXS  
Low Profile Mount

Model #	MT-RMR45	MT-RMR13C	MT-RMRKIT		MT-RMRGL	MT-T1AC	MT-T113C	MT-MROAC	MT-MRO13C	MT-MROXS
			MT-RMRAC	MT-RMRXS						
Length / Width	1.8" / 2.5"	1.8" / 1.1"	1.8" / 1.1"	1.8" / 1.1"	1.8" / 1.1"	1.9" / 1.2"	1.9" / 1.2"	1.5" / 1.2"	1.5" / 1.2"	1.5" / 1.2"
Saddle Height	N/A	0.95"	0.87"	0.40"	0.16"	0.96"	1.06"	0.73"	0.86"	0.20"
Weight	1.4 oz	1.6 oz	1.5 oz	1.4 oz	0.4 oz	1.3 oz	1.3 oz	0.9 oz	0.9 oz	0.6 oz





# UNIVERSAL SUPER SLIM RISER MOUNTS

- 6061-T6 ALUMINUM
- PRECISION MACHINED
- MIL-STD-1913 PICATINNY
- AVAILABLE COLOR(S)
  - Matte Black Anodized

### MT-RSX5S & MT-RSX5L:

- US PAT. D784482
- DIMENSION

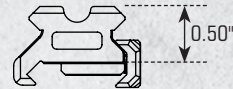

### MT-RSX7S & MT-RSX7L:

- US PAT. D784483
- DIMENSION

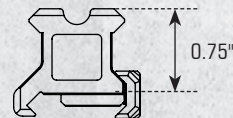

### MT-RSX8S & MT-RSX8L:

- DIMENSION

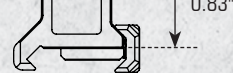

### MT-RSX1S & MT-RSX1L:

- US PAT. D784481
- DIMENSION

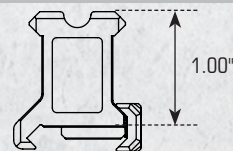

## Universal Super Slim Riser Mounts

- Significant Lightening Cuts Reduce Overall Weight and Bulk (Medium and High Profile Only)



- 0.50" MT-RSX5S
  - 0.75" MT-RSX7S
  - 0.83" MT-RSX8S
  - 1.00" MT-RSX1S
- 3 Slot**



- 0.50" MT-RSX5L
  - 0.75" MT-RSX7L
  - 0.83" MT-RSX8L
  - 1.00" MT-RSX1L
- 13 Slot**

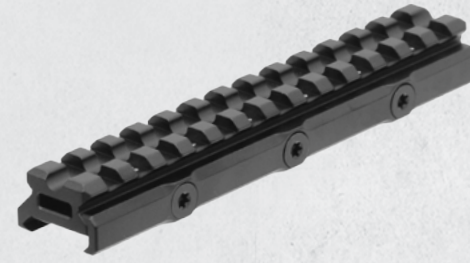

- MT-RSX20MOA
- 13 Slot / 20 MOA Elevated Compensation**

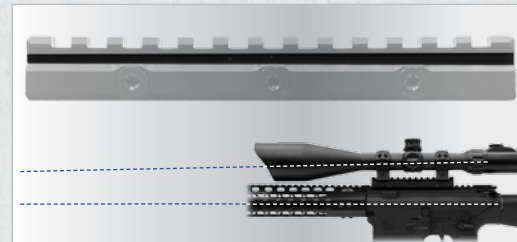

20MOA Compensation Maximizes Optic Elevation Adjustment for Zeroing at Long Range Distances



Utilizes Locking Torx Screws and Square-shaped Integral Recoil Stops for a Secure Zero Hold

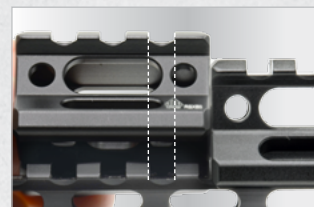

Rail Slots Index Perfectly with Handguard or Flat Top Slots

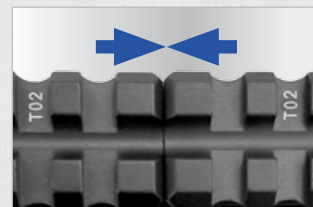

Multiple Riser Mounts Form One Continuous Picatinny Rail (Excludes MT-RSX20MOA)

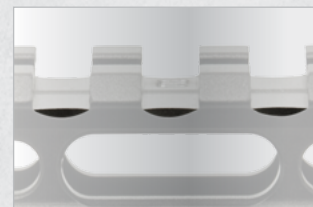

Scalloped Picatinny Slots for Snag Free Accessory Mounting

Model #	MT-RSX5S	MT-RSX7S	MT-RSX8S	MT-RSX1S	MT-RSX5L	MT-RSX7L	MT-RSX8L	MT-RSX1L	MT-RSX20MOA
Length	1.6"	1.6"	1.6"	1.6"	5.5"	5.5"	5.5"	5.5"	5.5"
Saddle Height	0.50"	0.75"	0.83"	1.00"	0.50"	0.75"	0.83"	1.00"	N/A
Picatinny Slots	3	3	3	3	13	13	13	13	13
Weight	0.9 oz	0.9 oz	1.0 oz	1.0 oz	2.7 oz	2.7 oz	2.8 oz	2.8 oz	2.7 oz



# UNIVERSAL RISER MOUNTS

## Universal Riser Mounts

- Precision Machined from Aircraft Aluminum with a Matte Black Finish
- Universal Riser Mount Fits All Picatinny Rails



- 0.59" MNT-RSQD403
- 3 Slot / QD Lever Lock**

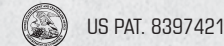

- 0.59" MNT-RSQD605
- 5 Slot / QD Lever Lock**



QD Lever Lock



- 0.50" MNT-RS05S2
- 2 Slot / Twist Lock**



Twist Lock



- 0.50" MNT-RS05L
  - 0.75" MNT-RS08L
  - 0.83" MNT-RS10L
- 13 Slot / Thumb Knob**



Thumb Lock



Laser Application



Foregrip Application



Optic Application



UTG

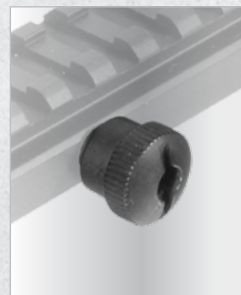

STANAG Compatible

Model #	MNT-RSQD403	MNT-RSQD605	MNT-RS05S2	MNT-RS05S3	MNT-RS08S3	MNT-RS10S3	MNT-RS05L	MNT-RS08L	MNT-RS10L
Length	1.6"	2.4"	1.2"	1.6"	1.6"	1.6"	5.5"	5.5"	5.5"
Saddle Height	0.59"	0.59"	0.50"	0.50"	0.83"	1.00"	0.50"	0.75"	0.83"
Locking Method	QD Lever Lock	QD Lever Lock	Twist Lock	Twist Lock	Twist Lock	Twist Lock	Thumb Knob	Thumb Knob	Thumb Knob
Picatinny Slots	3	5	2	3	3	3	13	13	13
Weight	2.3 oz	3.0 oz	1.1 oz	1.3 oz	1.9 oz	1.7 oz	4.2 oz	6.1 oz	6.9 oz





# AR15 MICRO GAS BLOCKS

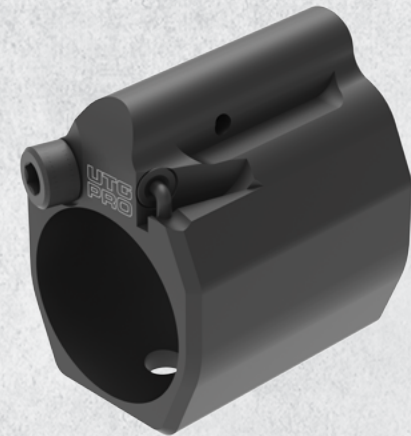

MTU012AG7

## UTG PRO® AR15 Adjustable Micro Gas Block

- 12 Position Gas Port Adjustments
- Low Profile, Fits Underneath Most Free Float Handguards
- Precision Machined Steel to Exacting Tolerances for .750" Diameter Barrels at the Gas Port
- Durable and Corrosion Resistant Manganese Phosphate Finish
- Includes Gas Tube Roll Pin, Serrated Self-locking Set Screws, Adjustment Tool, and Installation Tool



12 Position Gas Port Adjustments



Low Profile, Fits Underneath Most Free Float Handguards

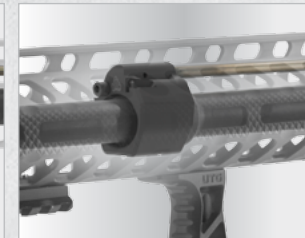

Compatible with Direct Impingement Systems

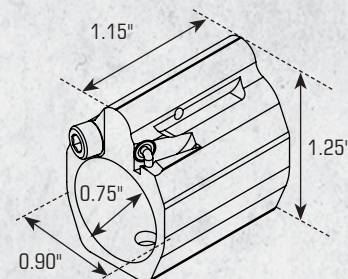

Model #	MTU012AG7
Inner Diameter	0.750"
Length	1.2"
Width	0.9"
Height	1.3"
Weight	1.9 oz



MNT-ARMGB01

## AR15 Micro Gas Block

- Low Profile, Fits Underneath Most Free Float Handguards
- Precision Machined Steel to Exacting Tolerances for .750" Diameter Barrels at the Gas Port
- Durable and Corrosion Resistant Manganese Phosphate Finish
- Includes Gas Tube Roll Pin, Serrated Self-locking Set Screws, and Installation Tool



Precision Machined Steel to Exacting Tolerances



Low Profile, Fits Underneath Most Free Float Handguards

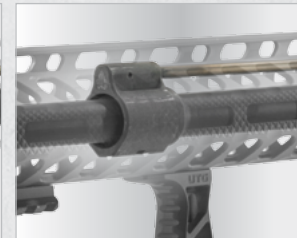

Compatible with Direct Impingement Systems

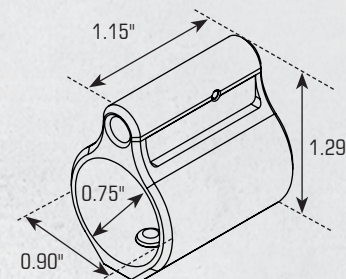

Model #	MNT-ARMGB01
Inner Diameter	0.750"
Length	1.2"
Width	0.9"
Height	1.3"
Weight	1.5 oz



# AR15 CARRY HANDLE | BARREL | HANDGUARD RAIL MOUNTS



MNT-993

## AR15 Carry Handle Rail Mount

- 12 Slot Top Picatinny Rail with Secondary Integral STANAG Mounting Base
- Constructed from Aircraft Aluminum with a Matte Black Finish
- Allows Use of Iron Sights
- Secured via Locking Knurled Thumb Nut



STANAG Compatible

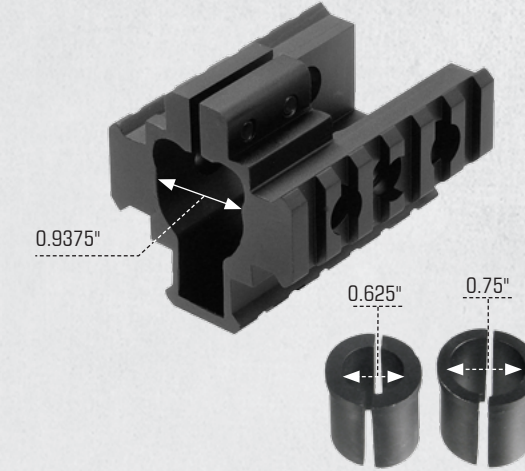

MNT-BR101TR-A

## AR15 Tri-Rail Barrel Mount

- AR15 Tri-rail Barrel Mount Compatible with A2 Front Sight with Bayonet Lug
  - Includes 2 Sets of Barrel Adaptors for Fitting on Standard, Bull, or Lightweight Barrel Profiles
  - Integral Sling Swivel Housing for Installation of Optional QD Sling Swivel TL-QDSW28
- [Also Refer to P. 157]



MNT-HGR16S

## Deluxe AR15 Handguard Picatinny Rails

- Compatible with AR15 Standard 2-piece Plastic handguard
- Includes Two Picatinny Rails with 12 Slots each for Installation at the 12 and 6 O'Clock Positions
- Complete with Mounting Hardware, Swivel Stud Housing, and Swivel Stud Adaptor



Tapered Design Mates with the Top and Bottom Handguards





# AK SUPER SLIM KEYMOD RAIL SYSTEMS

AK SUPER SLIM KEYMOD RAIL SYSTEMS

AK SUPER SLIM KEYMOD RAIL SYSTEMS

- MADE IN USA**
- 6061-T6 ALUMINUM
- PRECISION MACHINED
- MIL-STD-1913 PICATINNY
- OCTAGONAL PROFILE
- 922R COMPLIANT
- US PAT. D751663
- DIMENSION

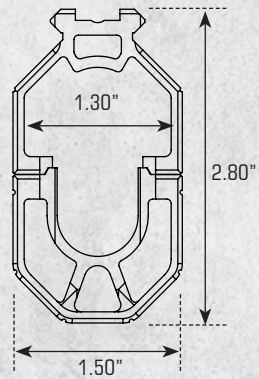

### AVAILABLE COLOR(S)

Matte Black Anodized

### PARTS INCLUDED

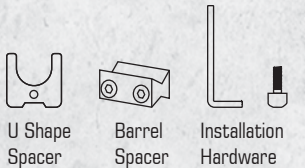
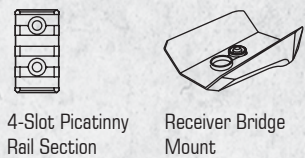

## THE AK REBORN



### UTG PRO® AK Super Slim Keymod Rail Systems

- Top and Bottom 2-piece Design with Internal Locking Screw Placement
- Ergonomic Octagonal Profile with Grooved Surface for a Solid Grip

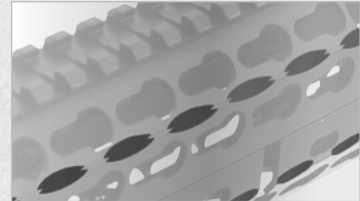
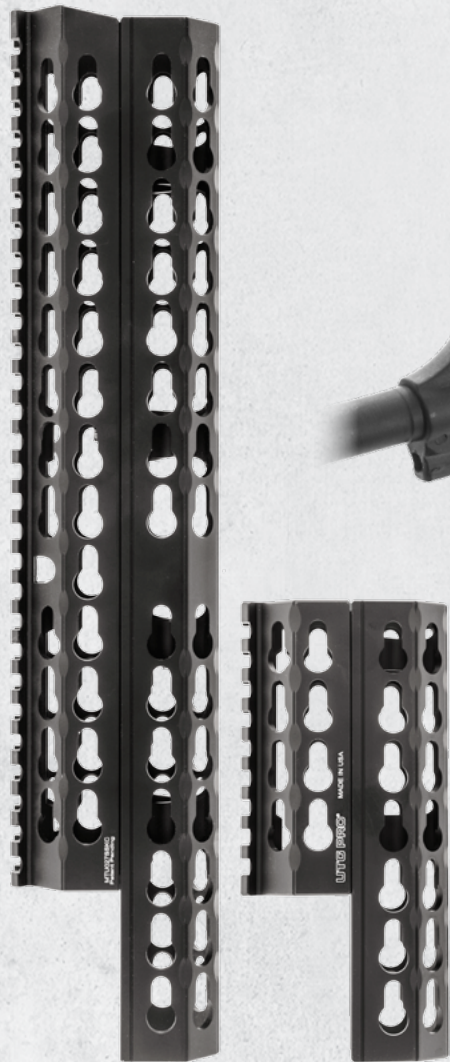

Ergonomic Finger Grooves for a Solid and Comfortable Grip

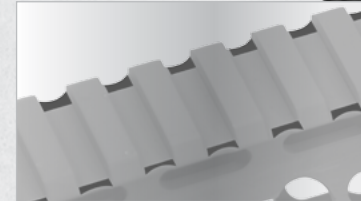

Scalped Top Picatinny Rail Edges for Snag Free Accessory Mounting

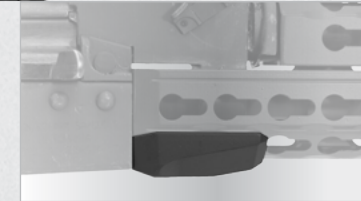

Receiver Bridge Mount for Smooth Interface with AK Receiver



MTU027SSKA

**13.5" Rail**  
Compatible with Romanian, Bulgarian AKs or Clones Equipped with Handguard Retainer Sling Loop

MTU027SSKC

**13.5" Rail**  
Compatible with Chinese AKs or Clones with Gas Block Sling Loop

MTU009SSK

**6" Rail**  
Compatible with Romanian, Bulgarian, and Chinese AKs or Clones

Model #	MTU027SSKA	MTU027SSKC	MTU009SSK
Length	13.5"	13.5"	6.0"
Keymod Slots	121	122	51
Top Picatinny Slots	28	28	9
Net Weight	13.6 oz	13.6 oz	5.1 oz



### Additional Keymod Accessories Available



MT-AFGK01  
**Keymod Angled Foregrip**  
[Also Refer to P. 148]



MT-FGK01  
**Keymod Super Slim Aluminum Vertical Foregrip**  
[Also Refer to P. 150]



TL-TRK01  
**Keymod Angled Index Mount**  
[Also Refer to P. 148]



TL-HSK01  
**Keymod Ultra Slim Hand Stop**  
[Also Refer to P. 149]

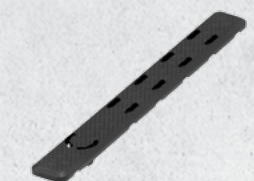

RB-HP25B (4/PACK)  
**Low Profile Keymod Rail Panel Covers**  
[Also Refer to P. 153]

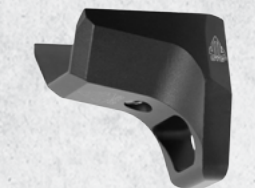

TL-HS02B  
**Keymod Hand Stop/Barricade Rest Kit**  
[Also Refer to P. 149]

AK SUPER SLIM KEYMOD RAIL SYSTEMS

AK SUPER SLIM KEYMOD RAIL SYSTEMS





# AK QUAD RAIL SYSTEMS



MADE IN USA



6061-T6 ALUMINUM



PRECISION MACHINED



MIL-STD-1913 PICATINNY



922R COMPLIANT



DROP IN



AVAILABLE COLOR(S)

Matte Black Anodized

## UTG PRO® AK Quad Rail Systems

- Integrally Machined QD Sling Swivel Housings
- Low Profile Top Rail with V-cut for Using Iron Sights



MTU009

### UTG PRO® Romanian/Chinese/US AK Quad Rail System

- Universal Design Fits Romanian, Bulgarian, Chinese, and US AKs or Clones Including Those with an Oversized Barrel and Rear Sight Block



12 Pc. Rubber Rail Guards Included



MTU010

### UTG PRO® AMD-65 Quad Rail System

- Fits Hungarian AMD-65 and Clones



12 Pc. Rubber Rail Guards Included



MTU011

### UTG PRO® YUGO AK Quad Rail System

- Fits Yugo AKs and Clones
- Also Compatible with Zastava N-PAP Series After Removal of Rear Handguard Retainer



11 Pc. Rubber Rail Guards Included



# AK SIDE MOUNT & LOW PROFILE QD RAIL SYSTEM



MTU016

### UTG PRO® AK Quick Detach Side Mount

- Precision Machined from 6061-T6 Aircraft Aluminum with a Matte Black Anodization
- Lightweight Design with U-cut Channel Top Rail for Reduced Weight
- Equipped with a 16 Slot Picatinny Top Rail and Detachable 6 Slot Side Rail
- Fits Most AKs and Clones with Side Optic Rail



U-cut Channel



TL-M47SR

### UTG AK Steel Side Plate

- Durable Steel Construction with a Matte Black Finish
- Fits Both Milled and Stamped AK Receivers and Accepts a Wide Variety of Side Optic Mounts
- Permanent Modification Required

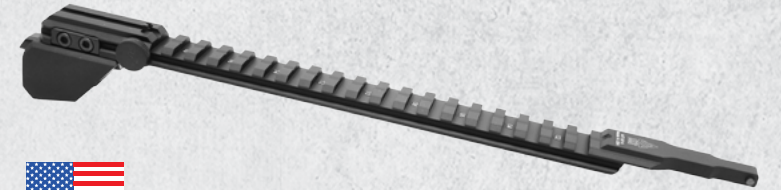

MTU014

### UTG PRO® AK QD Low Profile Top Rail System

- Low Profile 19 Slot Picatinny Top Rail
- Fits Romanian, Chinese, and US AKs or Clones, as well as, Saigas Equipped with Rear Sight Blade and Fixed Butt Stock
- **NOTE:** Does Not Work with Milled Receivers with a Slanted Tang



Precision Machined from 6061-T6 Aircraft Aluminum with a Matte Black Anodization



Quick Detachable for Ease of Disassembly and Maintenance

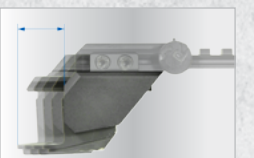

Adjustable Rear Block for Installation on Different AKs or Clones



Low Profile Design



Complete with Back-up Windage-adjustable Rear Sight



Convenient and Reliable Lock/Release Push Button

Model #	MTU009	MTU010	MTU011
Length / Width	8.4" / 2.1"	8.4" / 2.1"	6.5" / 2.1"
Top / Bottom / Left /Right Picatinny Slots	T:14 / B:14 / L:14 / R:14	T:15 / B:14 / L:14 / R:14	T: 9 / B:15 / L:15 / R:15
Net Weight	9.2 oz	9.2 oz	9.5 oz





# SKS | MOSIN NAGANT MOUNTS



922R COMPLIANT

MTU017

### UTG PRO® SKS Receiver Cover with Integrated Picatinny Rail and Shell Deflector

- Precision Cast and Machined High-strength Steel Base
- Top Rail Precision Machined from 6061-T6 Aircraft Aluminum with a Matte Black Anodization
- Full Length 22 Slot Top Picatinny Rail
- Precise and Repeatable 4 Point Locking Engagement of Receiver

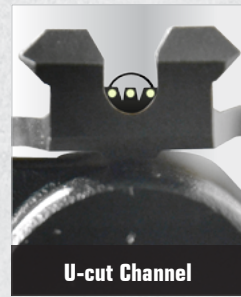

U-cut Channel

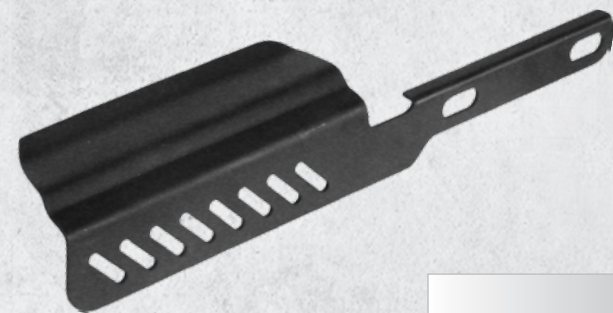

TL-SDSK01

### SKS Shell Deflector

- Made from Spring Steel with a Matte Black Finish
- Deflects Ejecting Spent Cartridges Away from Optics that May be Mounted
- Installation Screw Holes Compatible with UTG SKS Tri-Rail Mount, High Profile Mount, and Other Similar SKS Mounts

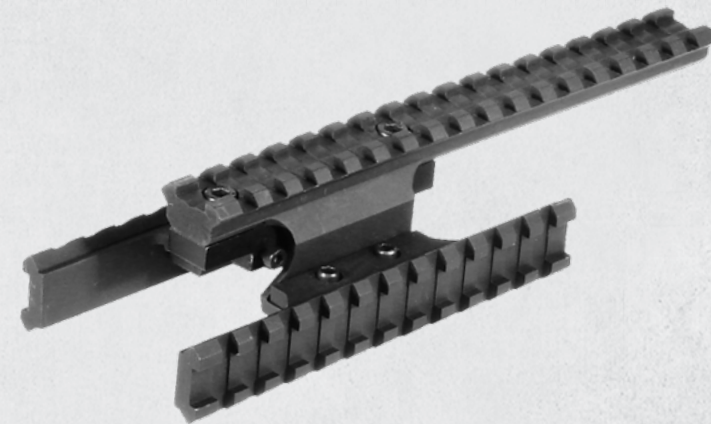

MNT-MNTR01

### Mosin Nagant Tri-rail Mount

- Steel Base with Adaptors to Fit the Rear Sight Housing of Full or Carbine Length Rifles
- Tri-rail Made from Aircraft Aluminum with a Matte Black Finish
- Extended Top Rail with 17 Slots to Provide Ample Space for Eye Relief Adjustment
- Removable 12 Slot Side Rails



X4

4 Pc. Rubber Rail Guards Included



Model #	MTU017	TL-SDSK01	MNT-MNTR01
Length / Width	9.1" / 2.1"	7.5" / 1.2"	8.0" / 2.4"
Net Weight	12.1 oz	2.1 oz	9.2 oz



# SHOTGUN MOUNTS

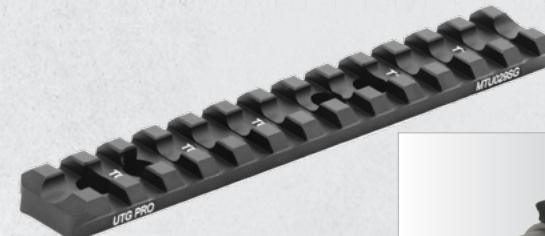

MTU029SG

### UTG PRO® Mossberg 500 Optic Mount

- The Michigan Difference - Enhanced Precision, Material Strength, and Quality Control
- Compatible with Drilled and Tapped Mossberg Shotguns
- **NOTE:** The Screws Included are for Mossberg 500s Made After 1998. For Earlier Versions, Please Contact Leapers for Appropriate Screws

MNT-MB500T • Overseas Production



MTU028SG

### UTG PRO® Remington 870 Optic Mount

- Precision Machined from Aircraft Aluminum with a Matte Black Anodized Finish
- Fits Drilled and Tapped Remington Model 870 / 1100 Shotguns and Clones



MNT-RM870A

### Remington 870 Optic Mount

- Fits 12 Ga Remington 870 Shotguns and Clones with Up to a 3" Chamber
- Precision Machined from Aircraft Aluminum with a Matte Black Finish
- Locking Bolts Directly Replaces Original Receiver Pins



922R COMPLIANT

MTU002

### UTG PRO® Saiga 12 Quad Rail System

- Fits Saiga 12 Ga. and Clones
- Precision CNC Machined from Aircraft Aluminum with a Matte Black Anodized Finish



X12

12 Pc. Rubber Rail Guards Included

### Short Top Rail / 20 Slot



### Long Top Rail / 31 Slot



Two Different Top Rails Provided



See-thru Top Rail



Model #	MTU029SG	MNT-MB500T	MTU028SG	MNT-RM870A	MTU002
Length / Width	5.5" / 0.4"	5.5" / 0.4"	6.1" / 0.8"	7.5" / 1.9"	13.7" / 2.3"
Top / Bottom / Left / Right Picatinny Slots	T: 13	T: 13	T: 14	T: 14	T: 28 / B:20 / L: 20 / R:20
Net Weight	1.2 oz	1.4 oz	1.6 oz	5.5 oz	17 oz





# M14 | M1 | 10/22 | BOLT ACTION MOUNTS



MNT-914V2

### 4-Point Locking M14/M1A Scope Mount

- Precision Machined from Aircraft Aluminum with a Matte Black Finish
- 6" Length with 15 Picatinny Top Slots
- 4-Point Locking System Interfaces with the Stripper Clip Guide and Three Different Points of the Receiver Providing a Rock Solid Foundation



MNT-M1C

### M1 Carbine Mount Complete With 1" Rings

- Precision Machined from Aircraft Aluminum with a Matte Black Finish



MNT-R22SS26

### Scout Rail for Ruger 10/22 Rifles

- 11.7" Length with 26 Picatinny Top Slots
- Lightening Cuts for Weight Reduction
- Free Float Rail Does not Touch Barrel or Forend
- Compatible with Drilled and Tapped 10/22 Receivers



MTU030T22

### UTG PRO® Low Profile Scope Mount For Ruger 10/22 Rifles

- Precision Machined from Aircraft Aluminum with a Matte Black Anodized Finish
- 4.67" Length with 11 Picatinny Slots
- Compatible with Drilled and Tapped Receivers



MNT-RM700

### Scope Mount for Remington 700 Long Action Rifles

- Solid Steel Construction
- 6.3" Length with 6 Picatinny Top Slots
- Clearance Cut for Reliable Case Ejection

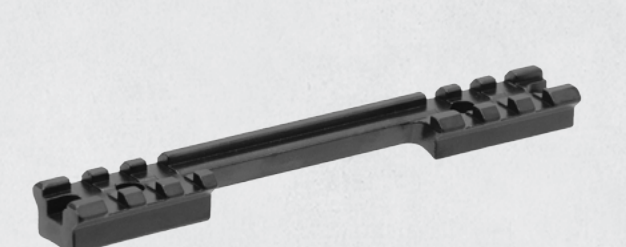

MNT-RM700S

### Scope Mount for Remington 700 Short Action Rifles

- Solid Steel Construction
- 5.47" Length with 6 Picatinny Top Slots
- Clearance Cut for Reliable Case Ejection



# MP5 | G3 | G36 MOUNTS

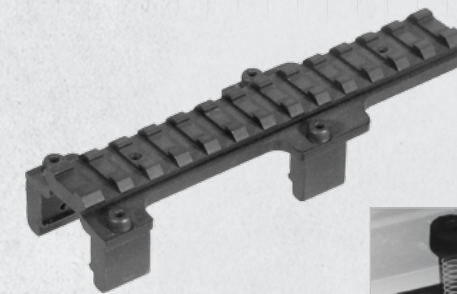

MNT-P669

### MP5 | G3 Low Profile Claw Mount

- Low Profile Top Rail with 13 Picatinny Slots
- Precision Machined from Aircraft Aluminum with a Matte Black Finish

Spring-Tensioned Claws and Receiver Set Screws for a Solid Installation

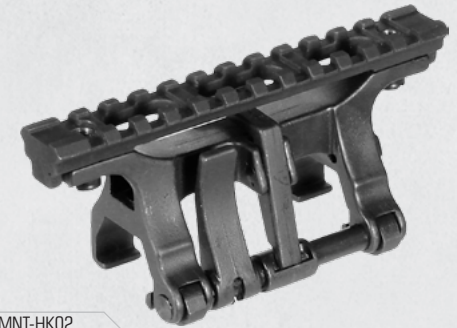
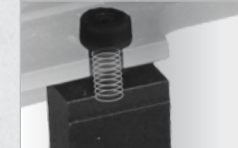

MNT-HK02

### MP5 | G3 Steel Claw Mount

- Complete with Detachable Steel Top Picatinny Rail and Secondary STANAG Mounting Base

STANAG Compatible

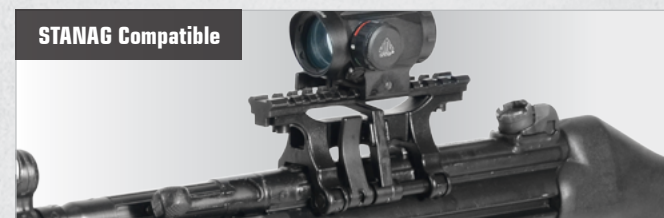

MNT-G3601

### G36 | SL8 Carry Handle Scope Mount

- Precision CNC Machined from Aircraft Aluminum with a Matte Black Finish
- 11.45" Length with 27 Picatinny Slots
- Lightweight and Low Profile, Securely Fits Into Standard G36/SL8 Carry Handle

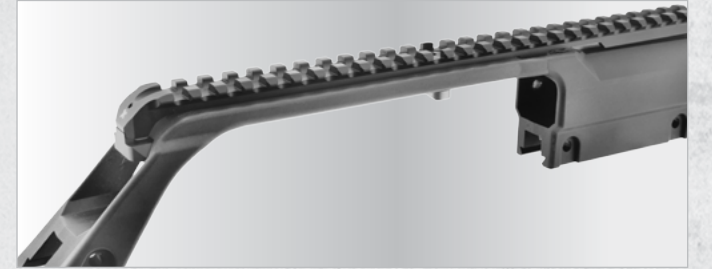

### G36 Picatinny Rail Sets

- Laser Engraved for Left, Right, and Bottom Designation and Accessory Placement



MNT-P503

### Set of 3

- One 6.08" Length Rail with 13 Picatinny Slots and Two 3.87" Length Rails with 7 Picatinny Slots



MNT-P505

### Set of 3

- Three 6.08" Length Rails with 13 Picatinny Slots



MNT-P501

### Set of 2

- Two 3.87" Length Rails with 7 Picatinny Slots





### Universal Rifle Barrel Mounts

- Precision Machined from Aircraft Aluminum with a Matte Black Finish
- Compatible Firearm Barrel Range: Diameter  $\varnothing$  .51" - .78"

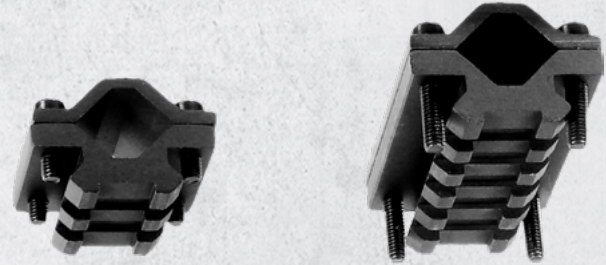

MNT-BR002S  
Single-Rail / 2 Slot

MNT-BR005S  
Single-Rail / 5 Slot



### Universal Shotgun Barrel Mount

- Precision Machined from Aircraft Aluminum with a Matte Black Finish
- Compatible Firearm Barrel Range: Diameter  $\varnothing$  .75"-1.10"
- Compatible Flashlight/Laser Range: Diameter  $\varnothing$  .75"-1.10" (Tri-rail Models Only)



MNT-BR003XLS  
Single-Rail / 3 Slot

MNT-BR003XL  
Tri-Rail / 3 Slot  
• Flashlight/Laser Housing

MNT-BR005XL  
Tri-Rail / 5 Slot  
• Flashlight/Laser Housing

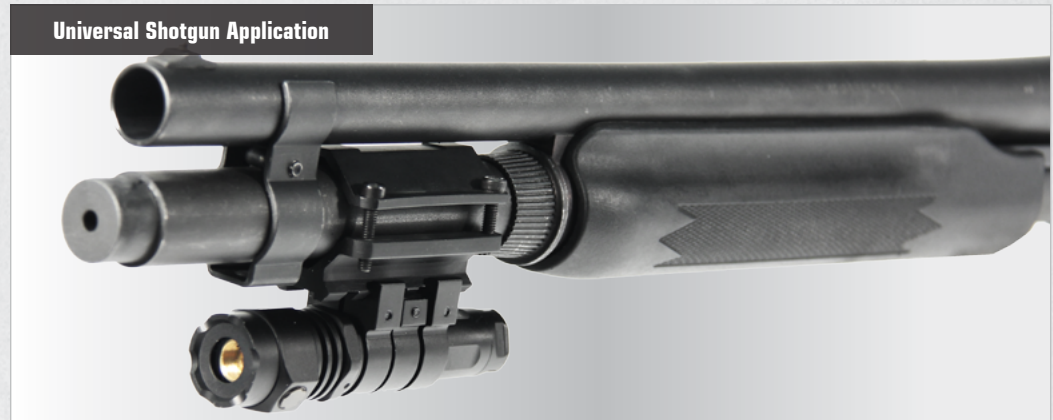

Model #	MNT-BR002S	MNT-BR005S	MNT-BR003XLS	MNT-BR003XL	MNT-BR005XL
Length / Width	1.2" / 1.4"	2.4" / 1.4"	1.6" / 1.7"	1.6" / 2.4"	2.4" / 2.4"
Top / Bottom / Left / Right Picatinny Slots	B: 2	B: 5	B: 3	B: 3 / L: 3 / R: 3	B: 5 / L: 5 / R: 5
Compatible Barrel Diameter	$\varnothing$ .51"- .78"	$\varnothing$ .51"- .78"	$\varnothing$ .75"- 1.10"	$\varnothing$ .75"- 1.10"	$\varnothing$ .75"- 1.10"
Compatible Flashlight/Laser Diameter	N/A	N/A	N/A	$\varnothing$ .75"- 1.10"	$\varnothing$ .75"- 1.10"
Net Weight	1.2 oz	2.0 oz	1.8 oz	4.4 oz	6.3 oz



MNT-DTW145  
**Universal Dovetail To Picatinny Rail Adaptor**  
• Precision Machined from Aircraft Aluminum with a Matte Black Finish  
• Compatible with 9mm-11mm Dovetail Rails



Optimized Interface to Fit Undersized, Standard, and Oversized Rounded and Flat Receivers



Model #	MNT-DTW145	MNT-PMTOWL-A	MNT-DNT06
Length / Width	5.7" / 0.8"	3.9" / 0.9"	4.7" / 1.0"
Slope	N/A	N/A	1.1/120
Upward at 30 Yds	N/A	N/A	10"
Top Picatinny Slots	14	9	11
Net Weight	2.4 oz	2.2 oz	3.8 oz

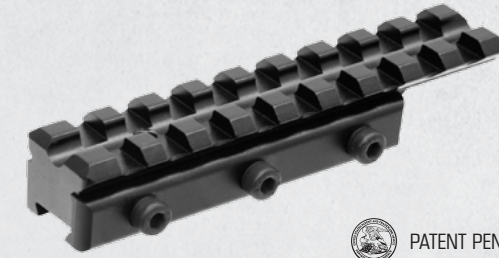

MNT-PMTOWL-A  
**Dovetail to Picatinny Adaptor Mount**  
• Precision Machined from Aircraft Aluminum with a Matte Black Finish  
• 3.94" Scalloped 9 Slot Picatinny Rail with 0.59" Saddle Height  
• Compatible with Flat Receivers Equipped with 9mm-11mm Dovetail Rails



Stop Pin to Prevent Forward and Rearward Movement from Birectional Recoil

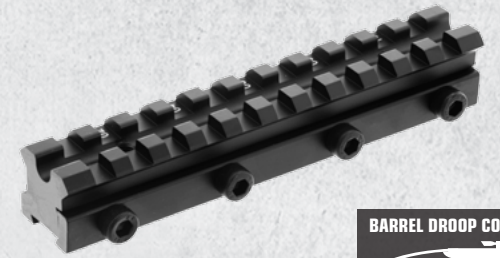
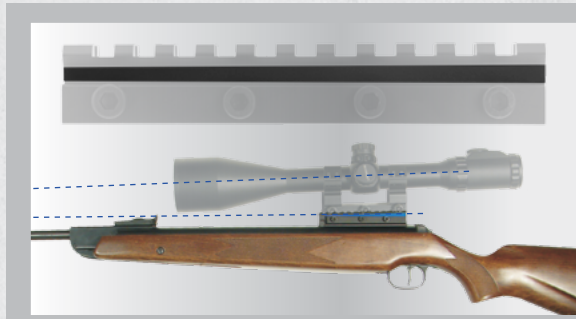

MNT-DNT06  
**Compensation Mount for T06 Tigger Equipped RWS Diana Air Rifles**  
• Precision Machined from Aircraft Aluminum with a Matte Black Finish  
• Compensation to Bring the POI (Point Of Impact) Up 10 Inches at 30 Yards



Dual Stop Pins to Prevent Forward and Rearward Movement from Birectional Recoil

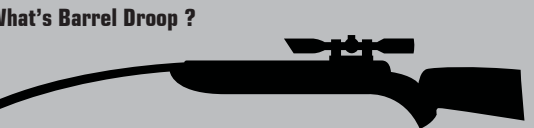

**What's Barrel Droop ?**  
Barrel droop means that the barrel's bore is pointing downward in relation to the plane of the scope base. Compensating meant cranking up the elevation knob to bring the pellet back up to where the crosshairs are at or inserting a shim. UTG's compensation mount takes care of this for you, and is designed with special slopes to compensate for the barrel droop of RWS Diana air rifles.